

**Panasonic**  
ideas for life



# AIR CONDITIONING & HEAT PUMP PRODUCTS

***INVERTER***



April 2012 ( version 1.1)



# New Panasonic Group

Contributing to the progress and development of society and enriching people's lives through manufacturing

Offering wider & more comprehensive solutions for life

**Panasonic**  
ideas for life

**Panasonic**

Panasonic Corporation  
Panasonic Electric Works Co., Ltd.



- Wide range of products, electrical appliances, business systems, residential, BtoB, healthcare
- Cutting-edge technologies
- Management infrastructures including sales platforms

**SANYO**

SANYO Electric Co., Ltd.



- Energy products - Solar cells, batteries
- Strong businesses in Commercial and Industrial equipment and devices

Our extensive range of products  
delivers customer satisfaction

# Panasonic Group Technology



ideas for life ... Today and Tomorrow

Ideas from consumers' viewpoint, ideas that are practical and useful, ideas that bring surprises and discoveries, ideas that make people happy, ideas that are innovative and interesting – ideas for life.

## We Like to Challenge Our Ideas and Products

The Panasonic robot-mascot powered by rechargeable EVOLTA batteries completed a two-month-long, 500-kilometer trip from Tokyo to Kyoto. The seven-inch-tall robot, Mr EVOLTA, weighing just 1 kilogram (standardized metric measurement), is a small green character made of plastic and carbon fiber with two Panasonic rechargeable EVOLTA batteries on its back, pulling a trailer containing ten more EVOLTA batteries. Human team mates helped Mr EVOLTA by pushing a device with an infra-red signal which the robot followed and by stopping once a day to recharge its batteries. Panasonic set this challenge to demonstrate the performance and durability of its new rechargeable AA batteries made from nickel-metal-hydride. The batteries combine the convenience of a disposable battery with the performance and cost benefits of a rechargeable battery. Two years ago, Mr EVOLTA, powered by two EVOLTA alkaline batteries, climbed a 530-meter rope to the top of the Grand Canyon in six hours and 46 minutes. The following year, it finished the 24-hour Le Mans endurance race of 23.7km and was subsequently recognized in the Guinness World Records for the longest distance covered by a battery-operated remote control car.

## U-Vacua Technology



Panasonic U-Vacua is a high-performance vacuum insulation panel (VIP) with very low thermal conductivity that performs about 20 times better than standard urethane foam. U-Vacua's improved performance saves space while increasing the energy efficiency of refrigeration applications, home appliances, buildings, and any products that require low energy loss from heat transfer. It is powerful enough to make a snowman survive in a hot sauna for 24 hours. We have tested it.

## Built for Extreme Conditions



Toughbooks are, like the name indicates, perfect companion to conditions that require durability and liability. With a rugged build, they are also the choice for the German skijump team, which uses them in various weather conditions – from rain to -20°C temperatures.

## Connected at 35,000 Feet Just Like on the Ground



Beside being a world leader in state-of-art in-flight entertainment and communication systems manufacturer, Panasonic Avionics has teamed up with Lufthansa to provide passengers with in-flight broadband connectivity on Lufthansa flights. Passengers will be able to use their own devices, such as laptops and smart phones, to wirelessly connect to the Internet – to browse, access social media sites, send/receive e-mails and more.

# History of Air Conditioning Group

## The Global Trusted Air Conditioning Brand

53 years since its establishment, Panasonic Air Conditioning Group has grown into a global company.

Through continuous quest for product innovations, the Group has evolved from manufacturing Compressor to providing Comprehensive Air Conditioning solutions. This has earned Panasonic, the reputation as the trusted brand for superior quality and reliable products in the industry.

# HISTORY

## of Air Conditioning Group

# 1958-2011

**1958** Started production and sales of Home Coolers  
The Electrical Appliance Business Group (Kadoma) started cooler production in March 1958. Started sales in May under the "Home Cooler" name.



**1961** Started exports of Home Coolers (to South Vietnam)

**1965** Launched Room Coolers



**1968** Began development of Rotary Compressors  
Later, their high efficiency and high quality attracted domestic and overseas air conditioner manufacturers. Began external sales.

**1972** Established overseas business base in Malaysia  
MAICO was established in Malaysia as the Aircon Group's first overseas base. From this time, MAICO started to export to Japan, Indonesia, Australia, and other markets. Panasonic started operating a twin base system with a presence in Japan and Malaysia.



**1983** Launched inverter Air Conditioner  
Started sales of Panasonic's first inverter air conditioners and has since gained increasing popularity. Inverter became the future technology of air conditioner market.  
Started shipments of Air Conditioners to Panasonic America

**1985** Began development of Scroll Compressors  
Began development of scroll compressors, offering high efficiency, low noise, and low vibration in comparison to rotary compressors.



**1990** Launched world's first Compact Scroll Compressor-equipped Air Conditioner

**1992** Developed industry's smallest outdoor air conditioning unit: "Chi-size"

**1993** Established Matsushita-Wanbao (Guangzhou) Air Conditioner (MWAC)  
Established Matsushita-Wanbao (Guangzhou) Compressor (MWCC)  
Established Matsushita Air Conditioner Engineering (Matsushita ACE)

**2003** Launched EcoCute on the back of better energy-saving technology

Launched accumulator-less, high-efficiency, CO<sub>2</sub> scroll compressor for EcoCute

Began production of Multi-split packaged air conditioner (mini-VRF)

**2005** Launched air conditioner automatic filter cleaning function (AC robot)



Product became extremely successful in the Japanese market. Since then, Panasonic launched a series of innovative products such as airstream robots and motion sensors which significantly improves Panasonic's air conditioner market share.

**2006** Aggregated global production of Panasonic compressors reached 200 million units

**2008** In 2008 Energy Conservation Grand Prizes, EcoCute won its first Director General Prize of Agency of Natural Resources and Energy, while Panasonic air conditioner won the Chairman Prize of the Energy Conservation Center of Japan Started Air to Water heat pump business in Europe



**2009** Established air conditioner dedicated sales company in Europe (PHAAE)  
Panasonic HA Air-Conditioning Europe (PHAAE) strengthened the commercial air conditioning business.

**2011** Integration of Sanyo HVAC USA into Panasonic Corporation of North America.



**1992 Pursuit of smallest outdoor size in the industry  
Focus entirely on the user**

Compact outdoor unit: "Chi-size" (small size)

With the change in the air conditioner market from "one unit per household" to "one unit per room," Panasonic responded with its "Chi-size" outdoor unit, which met demands for greater compactness and outdoor installation.

This "Chi-size" outdoor unit was about 75% the size of existing outdoor units, weigh seven kilograms lighter and required only around 66% of the installation area.

At the stage of fine-tuning, the structure and layout of the main components of outdoor units, Panasonic succeeded in changing the compressor from a vertical to a horizontal type. Because the "Chi-size" was efficient and quiet, many were in use over a long period of time.

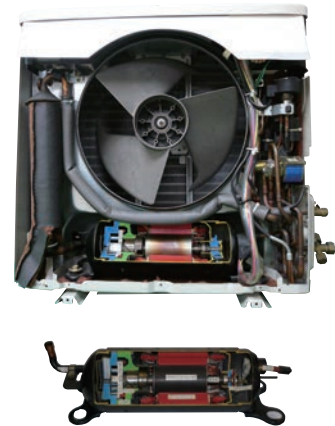

**2003 Making the 'environment' the central of product innovations**

CO<sub>2</sub> heat pump hot water heater (EcoCute)

- . CO<sub>2</sub> scroll compressor requires smaller installation area
- . Quiet, compact, lightweight



Introduced mini-VRF

Using inverter control, Panasonic developed new energy saving mini-VRF series for residences.

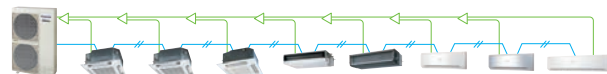

Accumulator-less, high-efficiency, CO<sub>2</sub> scroll compressor for EcoCute

Using a non-toxic, non-combustible natural refrigerant (CO<sub>2</sub>) as replacement for Freon helps reduce global warming.



**2008 New growth for the next generation**

Europe: Started Air to Water heat pump business

With environmental awareness growing around the world, hot water heating attracts considerable attention, particularly in Europe, as an alternative to conventional fuel-type heating systems. This market is expected to continue to grow in the future.

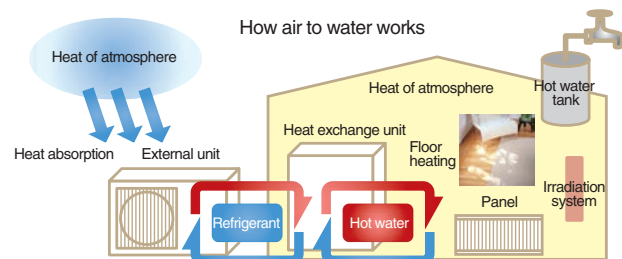







# Air Conditioners & Heat Pumps Line-up

## Panasonic: Your Best Choice in Ductless Split Air Conditioning & Heat Pump Systems

























Features Chart/Explanation

### COOLING ONLY MODELS / STANDARD TYPE

		Btu/h	9,000	12,000	18,000	22,000	24,000
		MODEL (System)	S9NKU-1	S12NKU-1	S18NKU-1, KS18NKU KS18NB4U	S22NKU-1	KS24NKU
Standard Type AIR CONDITIONER	Wall Mounted	 CS-S9NKUW-1 CU-S9NKU-1	 CS-S12NKUW-1 CU-S12NKU-1	 CS-S18NKU-1 CU-S18NKU-1	 CS-S22NKU-1 CU-S22NKU-1		
	Wall Mounted			LIMITED SUPPLY  CS-KS18NKU CU-KS18NKU		LIMITED SUPPLY  CS-KS24NKU CU-KS24NKU	
	Ceiling Recessed			LIMITED SUPPLY  CS-KS18NB4UW CU-KS18NKU			

























Panasonic's Ductless Split Air Conditioner & Heat Pump products offer wide versatility in solving your cooling and heating requirements for single or multiple rooms. The Indoor unit (evaporator) is mounted inside the room, enclosed in a handsome space saving cabinet. It is connected to the outdoor unit (condenser) via refrigerant lines & inter-unit wiring through a 3-1/2" opening in the wall. Since no ductwork is required, installation is simple, fast & efficient. The indoor unit has been uniquely designed to provide Whisper Quiet operation while delivering comfort throughout the room(s). Panasonic Ductless Split Systems bring together sleek styling in wall, duct or ceiling mounted systems, with whisper quiet operations, quality & reliability you can count on.

### COOLING ONLY MODELS / LOW AMBIENT TYPE













		Btu/h	9,000	12,000	18,000	24,000	26,000	30,000	36,000	42,000
		MODEL (System)	S9NKUA	S12NKUA KS12NB41A	S18NKUA, KS18NKUA KS18NB4UA	S24NKUA KS24NKUA	26PSK1U6, 26PST1U6 26PSU1U6, 26PSF1U6	KS30NKUA	KS36NKUA, 36PST1U6 36PSU1U6, 36PSF1U6	42PST1U6 42PSU1U6
Low Ambient Type AIR CONDITIONER	Wall Mounted	 CS-S9NKUA CU-S9NKUA	 CS-S12NKUA CU-S12NKUA	 CS-S18NKUA CU-S18NKUA	 CS-S24NKUA CU-S24NKUA			 CS-KS30NKU CU-KS30NKUA	 CS-KS36NKU CU-KS36NKUA	
	Wall Mounted			LIMITED SUPPLY  CS-KS18NKU	LIMITED SUPPLY  CS-KS24NKU	LIMITED SUPPLY  S-26PK1U6				
	Ceiling Suspended						 S-26PT1U6	 S-36PT1U6	 S-42PT1U6	
	Ceiling Recessed		 CS-KS12NB41	 CS-KS18NB4UW			 S-26PU1U6	 S-36PU1U6	 S-42PU1U6	
	Concealed Duct						 S-26PF1U6	 S-36PF1U6		
	Outdoor		 CU-KS12NK1A	 CU-KS18NKUA	LIMITED SUPPLY  CU-KS24NKUA	 U-26PS1U6		 U-36PS1U6	 U-42PS1U6	

\*Please refer to the model code on the back of this catalog.

### HEAT PUMP MODELS

Btu/h		9,000	12,000	18,000	24,000	26,000	30,000	36,000	42,000
MODEL (System)		E9NKUA	E12NKUA KE12NB41	E18NKUA, KE18NKU KE18NB4U	E24NKUA KE24NKU	26PEK1U6, 26PET1U6 26PEU1U6, 26PEF1U6	KE30NKU	KE36NKU, 36PET1U6 36PEU1U6, 36PEF1U6	42PET1U6 42PEU1U6
Low Ambient Type HEAT PUMP WITHOUT HEATER	Wall Mounted								
	Wall Mounted			LIMITED SUPPLY 	LIMITED SUPPLY 				
	Ceiling Suspended								
	Ceiling Recessed								
	Concealed Duct								
	Outdoor				LIMITED SUPPLY 				

### MULTI ZONE MODELS

AIR CONDITIONER	Series	S series / E series		KS series / KE series				
	Btu/h	9,000	12,000	7,000	9,000	12,000	18,000	24,000
	Indoor Unit	Wall Mounted						
	Ceiling Recessed							
Outdoor Unit	Btu/h	18,000		19,000		24,000		31,000
	Outdoor							

HEAT PUMP	Btu/h	9,000	12,000	7,000	9,000	12,000	18,000	24,000	
	Indoor Unit	Wall Mounted							
		Ceiling Recessed							
Outdoor Unit	Btu/h	18,000		19,000		24,000		31,000	
	Outdoor								

# Model Feature Chart

OP: Option

Features Chart/Explanation

		AIR CONDITIONERS				LOW-AMBIENT AIR CONDITIONERS						HEAT PUMPS						
		S9NKU-1 S12NKU-1 S18NKU-1 S22NKU-1	KS18NKU KS24NKU		S9NKUA S12NKUA S18NKUA S24NKUA	KS18NKUA KS24NKUA KS30NKUA KS36NKUA							E9NKUA E12NKUA E18NKUA E24NKUA	KE18NKU KE24NKU KE30NKU KE36NKU				
	Wall Mounted							26PSK1U6							26PEK1U6			
	Ceiling Suspended								26PST1U6 36PST1U6 42PST1U6							26PET1U6 36PET1U6 42PET1U6		
	Ceiling Recessed						KS12NB41A KS18NB4UA		26PSU1U6 36PSU1U6 42PSU1U6				KE12NB41 KE18NB4U			26PEU1U6 36PEU1U6 42PEU1U6		
	Concealed Duct									26PSF1U6 36PSF1U6								26PEF1U6 36PEF1U6
	Microprocessor-Controlled Operation	●	●	●	●	●	●	●	●	●	●	●	●	●	●	●	●	●
	Wireless Remote Control	●	●	●	●	●	●	●	OP	OP	OP	●	●	●	●	OP	OP	OP
	Wired Remote Control	OP	OP	OP	OP	OP	OP	OP	●	●	●	OP	OP	OP	OP	●	●	●
	Self-Diagnosing Function	●	●	●	●	●	●	●	●	●	●	●	●	●	●	●	●	●
	Dry Mode	●	●	●	●	●	●	●	●	●	●	●	●	●	●	●	●	●
	3 Fan Speeds and Automatic Fan Operation	●	●	●	●	●	●	●	●	●	●	●	●	●	●	●	●	●
	Air Sweep Control	●	●	●	●	●	●	●	●	●	-	●	●	●	●	●	●	-
	Louver Control	●	●	●	●	●	●	●	●	●	-	●	●	●	●	●	●	-
	Automatic Heating and Cooling Changeover	-	-	-	-	-	-	-	-	-	-	●	●	●	●	●	●	●
	Night Setback Mode for Cooling and Heating	-	●	●	-	●	●	-	-	-	-	-	-	●	-	-	-	-
	Hot Start Heating System	-	-	-	-	-	-	-	-	-	-	●	●	●	●	●	●	●
	24-Hour Clock with ON/OFF ProgramTimer	●	●	●	●	●	●	●	●	●	●	●	●	●	●	●	●	●
	1-Hour OFF Timer	-	●	●	-	●	●	-	-	-	-	-	●	●	-	-	-	-
	Weekly Timer	-	-	-	-	-	-	OP	●	●	●	-	-	-	OP	●	●	●
	System Controller	-	-	-	-	-	-	OP	OP	OP	OP	-	-	-	OP	OP	OP	OP
	Filter Sign	-	-	-	-	-	-	●	-	●	-	-	-	-	●	●	-	-
	Automatic Restart Function after Power Failure	●	●	●	●	●	●	●	●	●	●	●	●	●	●	●	●	●
	Fresh Air Intake	-	●	●	-	-	●	-	OP*	OP	OP*	-	-	●	-	OP*	OP	OP*
	Branch Extension	-	-	●	-	-	●	-	●	●	●	-	-	●	-	-	●	●
	Built-In Drain Pump	-	-	●	-	-	●	-	-	●	●	-	-	●	-	-	●	●
	Low Ambient Operation	-	-	-	-	●	●	●	●	●	●	●	●	-	●	●	●	●
	Electric Expansion Valve	● (S18/22)	●	●	●	●	●	●	●	●	●	●	●	●	●	●	●	●
	ODP=0 Refrigerant	●	●	●	●	●	●	●	●	●	●	●	●	●	●	●	●	●
	Quiet Mode	●	●	●	●	●	●	-	-	-	-	●	●	●	-	-	-	-
	Anti-microbial Filter	●	-	-	●	-	-	-	-	-	-	●	-	-	-	-	-	-
	Blue Fin Condenser	●	-	-	●	●	-	-	-	-	-	●	-	-	-	-	-	-

\* Field Supplied



# Features



## Microprocessor-Controlled Operation

Microprocessor control ensures that the temperature and humidity levels in the room are always comfortable.



## Wireless Remote Control

Panasonic's infrared Remote Control with an easy-to-read LCD Display, gives the user the capability to adjust & set: temperature, sweep (louver control), fan speeds, timer and more, for complete automatic operation.



## DRY Dry Mode

By coupling compressor and fan operation, intermittent operation can be precisely controlled according to room temperature, so that air is efficiently dehumidified.



## 3 Fan Speeds and Automatic Fan Operation

Convenient microprocessor control automatically adjusts fan speed to High, Medium or Low. According to room temperature to maintain a comfortable airflow throughout the room.



## Air Sweep Control

The air sweep function moves the louver up and down in the air outlet, directing air in a "sweeping" motion around the room and providing comfort in every corner.

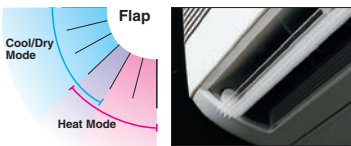

## Louver Control

Louver can be manually set to the desired angle by remote control.



## Automatic Heating and Cooling Changeover

After setting the temperature and functions you desire, just relax. If the room temperature is higher than the set temperature, cooling operation begins. If the room temperature is lower than the set temperature, heating operation begins. During normal thermostat cycle operation, cooling and heating operations automatically change in accordance with set temperature, time and room temperature. (Single Zone Heat Pump unit only)



## 1-hour OFF Timer

When this button is pushed either while the unit is operating or while it is stopped, the unit will operate for one hour and then switch off automatically.



## 24-hour Clock with ON/OFF Program Timer

The remote control unit allows you to set a wide variety of timer-based operations. Such functions include automatic ON/OFF with a timer setting, same time ON/OFF every day, ON timer, OFF timer and Combination timer.



## Night Setback Mode for Cooling and Heating

**Cooling and DRY Mode:** With the Night Setback Mode, the air conditioner automatically raises the setting temperature 2°F after 30 minutes, and then another 2°F after the next 30 minutes.

**Heating Mode:** With the Night Setback Mode, the setting temperature is automatically lowered 4°F after 30 minutes, and then another 4°F after the next 30 minutes. This saves energy without sacrificing comfort and is ideal for gentle cooling and heating.

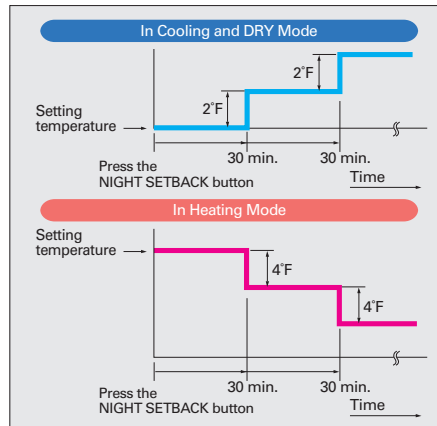

## Automatic Restart Function after Power Failure

This feature allows the system to automatically resume operation at its preset program, after power is restored from a power failure.



## Hot Start Heating System

Right from the start, air is warm and comfortable. The Hot Start Heating System prevents any cold blasts at the beginning while the heat pump is warming up. (Heat pump unit only)



## Built-In Drain Pump

Max. head 20 inches from the discharge of the indoor unit. Condensation pump is only for allowing drain line to meet minimum gravity flow requirements.



## Electric Refrigerant Control Valve

The circulation volume of the refrigerant is controlled by a pulse type electric control valve. In order to attain optimum efficiency, when the power is switched ON, the opening degree of the electric control valve is controlled between 90 and 480 steps.



## Quiet Mode

LOW, low fan speed for extra quiet operation.

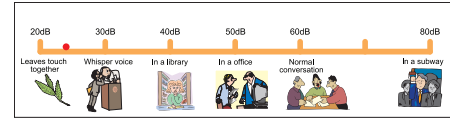

## Filter Sign

Filter sign informs you when filter maintenance is necessary.

2,500hrs : U1-series / 150 hrs : K1-series



## Self-Diagnosing Function

Details of previous warnings are stored and can be verified on the liquid crystal display. This makes it easier to diagnose malfunctions, greatly reducing service labor. (Wired remote controller)



## Anti-microbial Filter

Anti-microbial Filter by 3M. This filter is treated to inhibit the growth of mold and mildew.

### Test Comparison

	Microbial Growth Rating	
	7 days	28days
Anti-microbialFilter	No growth	No growth
Normal Filter Paper	60% growth	60% growth

\*Tested per ASTM G21-96



## Blue Fin Condenser

Condensers can take a beating from exposure to salty air, rain and other corrosive factors. Panasonic has tripled the life of our condensers with an original anti-rust coating. (Note:Based on Panasonic internal test result)

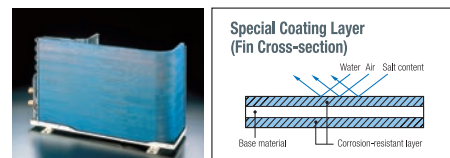

# Remote Controller Options for Models 26,000 Btu's and Larger

## Wired Remote Controllers (Except KE30/36NKU, KS30/36NKU)

### Simplified Remote Controller



CZ-RE2C



CZ-RELC2 (with Backlight)

NEW

### Timer Remote Controller



CZ-RTC2

### System Controller



CZ-64ESMC1U

#### Key Features (Simple Remote):

- Thin and Easy To Read
- Simple To Install and Use
- Can Be Adapted for Use On All 26,000 through 42,000 Utu/h Indoor Units.
- Mode
- Fan Speed Control
- Set Temperature
- On/Off
- Airflow Direction
- Perfectly Suited for Applications Where Simpler Functionality is Required (ie: Hotel Rooms, Nursing Homes, Offices)

#### Key Features (Standard Remote/7 Day Timer):

- Thin and Easy To Read
- Simple To Install and Use
- Can Be Adapted for Use On All Indoor Units
- Fan Speed Control
- Airflow Direction
- Operating Mode (Heating/Cooling/Auto/Dry/Fan)
- Vacation Mode for Continued Energy Efficiencies
- Full 7 Day Set-Back Functionality, With Up To 6 Time Periods/Day
- Full System Diagnostic Capability (Diagnostic History Provides Immediate View of System Past and Present.)

#### Multiple Zone Controllers.

#### The Air Conditioning Gateway.

Panasonic's system and intelligent controls are the central nervous system to the conditioning system. The gateway to all data, temperature and system diagnostics. The heart and soul of conditioning.

#### Key Features (System Control):

- Controls Up To 64 Units Into 4 Individualized Zones
- Alarm and Operational Signal Output
- Single Access Points for All Connected Wired Remotes

## Wireless Remote Controllers

Wireless Remote Controller	Applicable Unit	U1-series (Ceiling Recessed Type) T1-series (Ceiling Suspended Type)	For All Large capacity series Indoor Units
<p><b>K1-series</b> CZ-RWSK1U</p>		<p><b>Built-in type</b></p> <ul style="list-style-type: none"> <li>• Signal receiving unit can be installed in the outer panel of indoor unit.</li> <li>• Control panel can be installed in the inside indoor unit.</li> </ul> <p>CZ-RWSU2U</p>	<p><b>External type</b></p> <ul style="list-style-type: none"> <li>• Separate type signal receiving unit.</li> </ul> <p>CZ-RWSC1U</p>

## Remote Controllers Functions

		Timer Remote Controller (CZ-RTC2)	System Controller (CZ-64ESMC1U)	
Function	ON/OFF	●	● (Collective/Individual)	
	Operation mode switch	Heating	●	● (Individual)
		Dry	●	● (Individual)
		Cooling	●	● (Individual)
		Fan	●	● (Individual)
	Temp setting	●	● (Individual)	
	Fan speed setting (Hi/Mid./Lo/Auto)	●	● (Individual)	
	Auto flap	Auto airflow direction setting	●	●
		Arbitrary airflow direction setting	●	●*
	Sweep (Flap swing)	●	●*	
Sensor temp. display	●	×		
Self-diagnostic function	●	●		
System	Central control (at hand inhibited)	×	●	
	Group control	● (Up to 8 units)	● (Up to 64 groups)	
	Concurrent use with weekly timer	●	●	
Setting Range	Cooling, dry (°F)		65 - 86	
	Heating (°F)		61 - 79	

●: Controllable  
×: Uncontrollable

#### Note:

If you use both remote controller and system controller concurrently, both controllers can be used on a last-signal priority basis.

# Benefits

- High Efficiency systems up to 21 SEER
- Inverter Driven variable speed rotary compressor
- Precise compressor speed to match the building needs
- Quiet operation
- Designed to run longer periods at reduced speeds to improve dehumidification with local codes on wire size
- Quick and easy installation of indoor and outdoor units
- Wired & wireless remote controllers available at option (Except for some models).
- Single Point Power Supply reduces installation costs (Comply with local codes on wire size)
- 7 Year compressor warranty and 5 year parts warranty

\*These wiring diagrams are for reference only. Please refer to installation manual for details.  
 \*Please be sure to follow National/Local codes for installation

## 9,000 - 24,000 Btu/h single zone, KS30/36 NKUA, KE30/36NKU

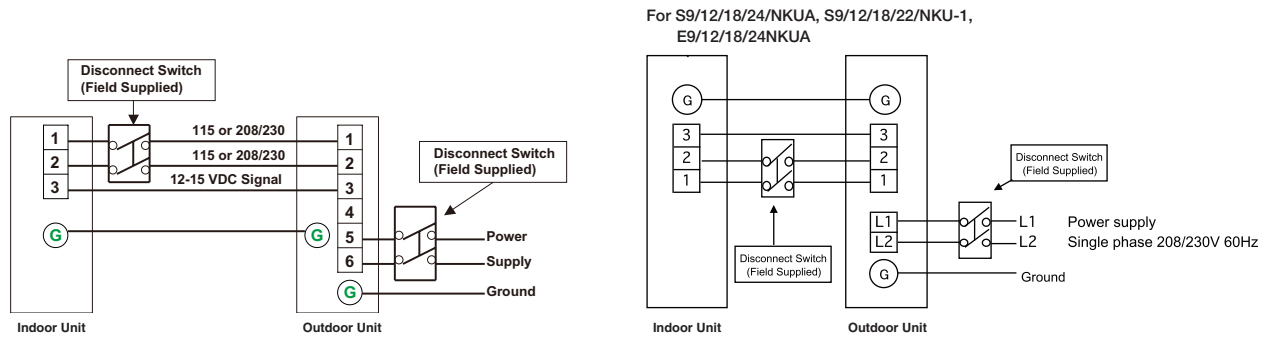

## 26,000 - 42,000 Btu/h single zone wiring schematic (Except KS30/36NKUA, KE30/36NKU)

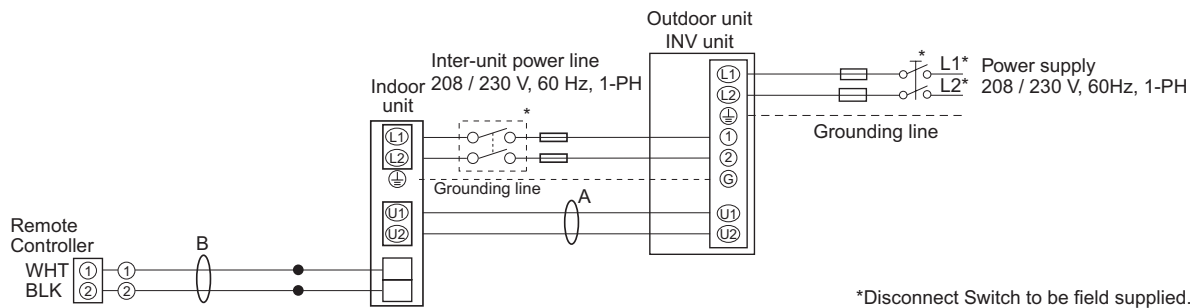

## RAC Multi wiring schematic (example shown is with 4 indoor units)

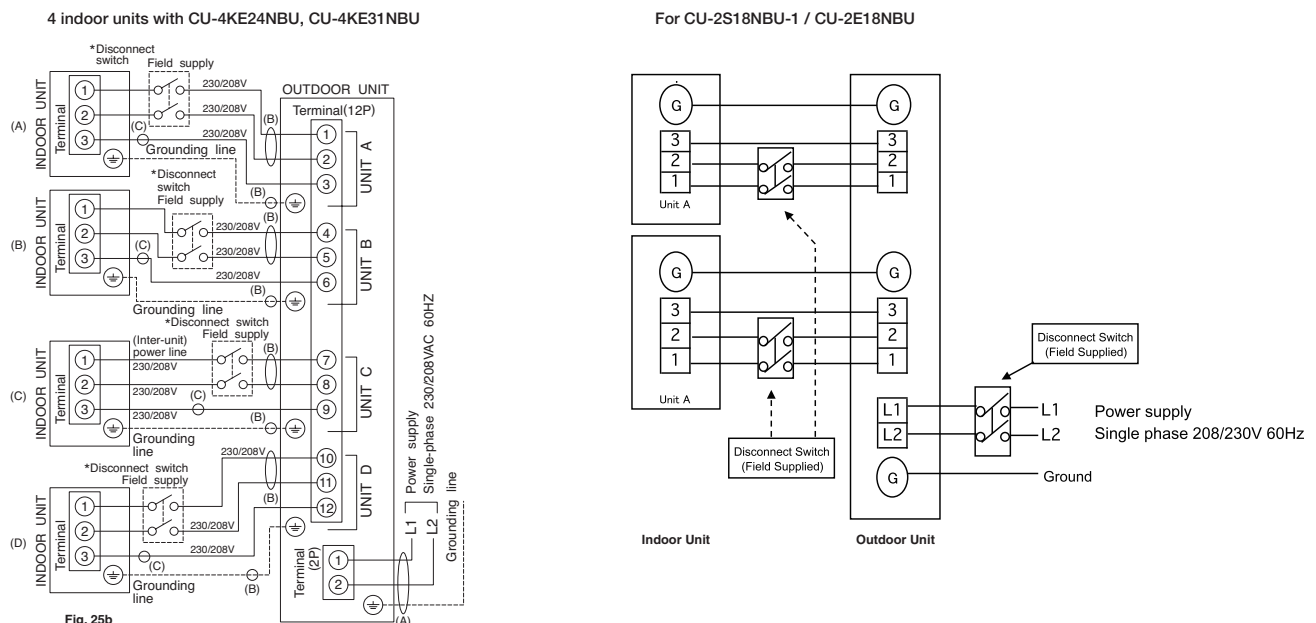

# Welcome to the New Panasonic's Air Conditioner Product Line.



## LEAVING THE OTHERS BEHIND

Panasonic's new ductless split system is more attractive than ever. Sleek and stylish, with a distinctive, curved form that blends well with virtually any decor.

Complementing today's modern interiors, they can add a refreshingly cool design accent to any room in the house.



# Advanced Inverter Technology — Less Energy and More Comfort



## How can an inverter save energy?

The inverter constantly adjusts compressor rotation speed to provide optimum performance at all times. This extremely precise operation enables quick cooling while reducing power consumption compared to conventional non-inverter units.

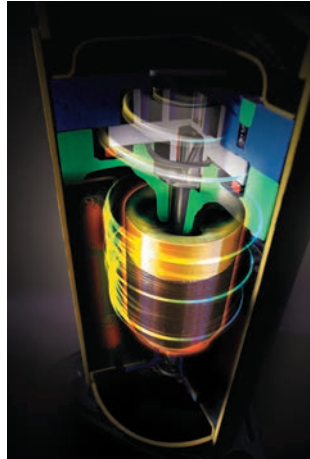

### ■ Even Wider Output Power Range

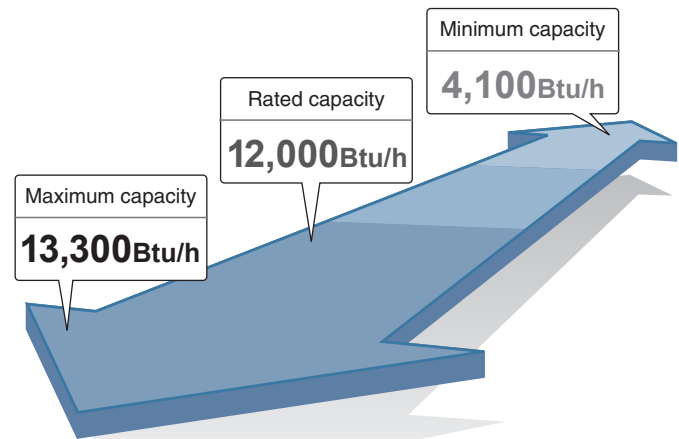

The graph shows E12NKUA's wide power output range during cooling.

### ■ The Advantages of Inverter Control

Comparing inverter and non-inverter air conditioners to cars...

\*Image of output power fluctuation

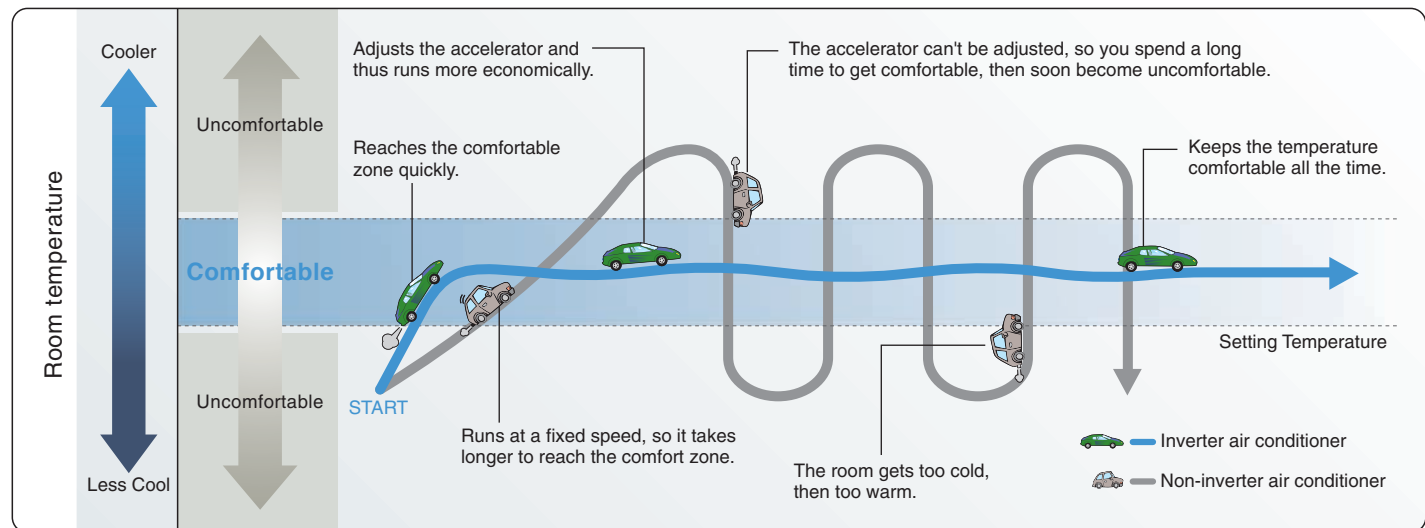

### Panasonic ductless split system designed to care for you

With more than 50 years of experience, exporting to more than 125 countries around the world, Panasonic is unquestionably one of the leaders in the air conditioning business. Together with more than 200 million compressors produced in accumulation, you are assured of the high quality of Panasonic's air conditioners.



# Wall-Mounted Air Conditioners Low Ambient Models

## S9NKUA / S12NKUA



**Indoor Unit**  
CS-S9NKUA / CS-S12NKUA



**Outdoor Unit**  
CU-S9NKUA / CU-S12NKUA



Wireless Remote Controller



Wired Remote Controller (CZ-RD516C) (Optional)

## S18NKUA / S24NKUA



**Indoor Unit**  
CS-S18NKUA / CS-S24NKUA



**Outdoor Unit**  
CU-S18NKUA / CU-S24NKUA



Wireless Remote Controller



Wired Remote Controller (CZ-RD516C) (Optional)



Wall Mounted Air Conditioner

Wall Mounted Air Conditioners										
Model No.	S9NKUA		S12NKUA		S18NKUA		S24NKUA			
Unit Model No.	Indoor Unit	Outdoor Unit	Indoor Unit	Outdoor Unit	Indoor Unit	Outdoor Unit	Indoor Unit	Outdoor Unit		
	CS-S9NKUA	CU-S9NKUA	CS-S12NKUA	CU-S12NKUA	CS-S18NKUA	CU-S18NKUA	CS-S24NKUA	CU-S24NKUA		
<b>Performance &amp; Electrical Ratings</b>										
Capacity	Cooling	Btu/h	8,500 (4,100-10,200)		12,000 (4,100-13,300)		17,100(-)		24,000(-)	
	Heating	Btu/h	---		---		---		---	
Moisture Removal	High	Pints/H	1.3		2.5		---		---	
Dry Air Flow	High	CFM	395		425		---		---	
SEER	Cooling		21.0		20.0		18.0		17.5	
EER	Cooling		13.1		12.0		13.2		10.2	
HSPF	Heating		---		---		---		---	
Power Supply	V, Phase, Hz		230/208V, 1PH, 60Hz		230/208V, 1PH, 60Hz		230 / 208V, 1PH, 60Hz		230 / 208V, 1PH, 60Hz	
Running Amps	Cooling	A	3.1/3.5(-4.4)		4.7/5.2(-6.8)		5.95/6.60		10.75/11.90	
	Heating	A	---		---		---		---	
Power Input	Cooling	W	650(250-850)		1,000(250-1,150)		1,300(-)		2,350(-)	
	Heating	W	---		---		---		---	
Back-up Heater		kW	---		---		---		---	
Fuse or Circuit Breaker Capacity	A		15		15		20		20	
<b>Features</b>										
Controls	Microprocessor		Microprocessor		Microprocessor		Microprocessor		Microprocessor	
Low Ambient Control	Equipped		Equipped		Equipped		Equipped		Equipped	
Wireless Remote Controller	Included		Included		Included		Included		Included	
Wired Remote Controller(optional)	CZ-RD516C		CZ-RD516C		CZ-RD516C		CZ-RD516C		CZ-RD516C	
Fan Speeds	5 Speeds + Auto		5 Speeds + Auto		5 Speeds + Auto		5 Speeds + Auto		5 Speeds + Auto	
Timer	24hr Program		24hr Program		24hr Program		24hr Program		24hr Program	
Air Deflection	Horizontal	Manual	Manual		Automatic		Automatic		Automatic	
	Vertical	Automatic	Automatic		Automatic		Automatic		Automatic	
Air Filter	Washable + Anti Microbial Filter		Washable + Anti Microbial Filter		Washable + Anti Microbial Filter		Washable + Anti Microbial Filter		Washable + Anti Microbial Filter	
Refrigerant	R-410A		R-410A		R-410A		R-410A		R-410A	
Refrigerant control	Electric Expansion Valve		Electric Expansion Valve		Electric Expansion Valve		Electric Expansion Valve		Electric Expansion Valve	
Operation Sound	In(Hi / Lo/ Q-Lo)	dB-A	40 / 25 / 20		43 / 28 / 20		---		---	
	Outdoor(Hi)	dB-A	47		48		---		---	
Refrigerant Piping	Type		Flare		Flare		Flare		Flare	
	Discharge	inches	1/4"		1/4"		1/4"		1/4"	
	Suction	inches	3/8"		1/2"		1/2"		5/8"	
Refrigerant Pipe Length		Ft.	Max. 66		Max. 66		Max. 100		Max. 131	
Elevation Difference*	Outdoor Above	Ft.	Max. 49		Max. 49		Max. 49		Max. 49	
	Outdoor Below	Ft.	Max. 49		Max. 49		Max. 49		Max. 49	
<b>Dimensions &amp; Weight</b>										
Height	inches		Indoor Unit	Outdoor Unit	Indoor Unit	Outdoor Unit	Indoor Unit	Outdoor Unit	Indoor Unit	Outdoor Unit
			11-7/16"	21-9/32"	11-7/16"	21-9/32"	11-7/16"	31-5/16"	11-7/16"	31-5/16"
Width	inches		34-9/32"	30-23/32"	34-9/32"	30-23/32"	42-5/32"	34-15/32"	42-5/32"	34-15/32"
Depth	inches		8-1/16"	11-13/32"	8-1/16"	11-13/32"	9-9/32"	12-5/8"	9-9/32"	12-5/8"
Net Weight	Lbs.		20.0	82.0	20.0	82.0	26.0	115.0	26.0	117.0

S18/24: Tentative spec.

\* This is maximum elevation difference when the indoor unit is located above the outdoor unit. (Refer to the table on the P.34 in the catalog for more detail.)

# Wall-Mounted Air Conditioners Low Ambient Models

## KS18NKUA / KS24NKU



**Indoor Unit**  
CS-KS18NKU / CS-KS24NKU



**Outdoor Unit**  
CU-KS18NKUA / CU-KS24NKUA

Wireless Remote Controller  
Wired Remote Controller (optional)

LIMITED SUPPLY

## 26PSK1U6



**Indoor Unit**  
S-26PK1U6



Wireless Remote Controller  
Wired Remote Controller (optional)

## KS30NKUA / KS36NKUA



**Outdoor Unit**  
CU-KS30NKUA  
CU-KS36NKUA

Wireless Remote Controller  
Wired Remote Controller (optional)



Wall Mounted Air Conditioners											
Model No.	KS18NKUA (Limited Supply)		KS24NKUA (Limited Supply)		26PSK1U6		KS30NKUA		KS36NKUA		
Unit Model No.	Indoor Unit	Outdoor Unit	Indoor Unit	Outdoor Unit	Indoor Unit	Outdoor Unit	Indoor Unit	Outdoor Unit	Indoor Unit	Outdoor Unit	
	CS-KS18NKU	CU-KS18NKUA	CS-KS24NKU	CU-KS24NKUA	S-26PK1U6	U-26PS1U6	CS-KS30NKU	CU-KS30NKUA	CS-KS36NKU	CU-KS36NKUA	
<b>Performance &amp; Electrical Ratings</b>											
Capacity	Cooling	Btu/h 17,500 (4,000-17,500)		24,200 (4,000-24,200)		25,200 (9,500-25,200)		30,600 (10,900-30,600)		34,000 (10,900-34,000)	
	Heating	---		---		---		---		---	
Moisture Removal	High	Pints/H 4.89		4.89		8.1		9.57		10.64	
Dry Air Flow	Hi / Med / Low	CFM 524 / 441 / 377		659 / 541 / 494		559 / 475 / 390		630 / 530 / 412		630 / 530 / 412	
SEER	Cooling	20.0		17.0		14.9		16.0		16.0	
EER	Cooling	11.7		9.8		8.9		9.3		8.5	
HSPF	Heating	---		---		---		---		---	
Power Supply	V, Phase, Hz	230 / 208V, 1PH, 60Hz		230 / 208V, 1PH, 60Hz		230 / 208V, 1PH, 60Hz		230 / 208V, 1PH, 60Hz		230 / 208V, 1PH, 60Hz	
Running Amps	Cooling	A 7 / 7.7(1.2-7.7)		10.8 / 12.1(1.3-12.1)		15.3 / 16.9		16.5 / 18		20 / 21.9	
	Heating	A ---		---		---		---		---	
Power Input	Cooling	W 1,500 / 1,500(250-1,500)		2,460 / 2,460		2,840 / 2,840		3,290		4,000	
	Heating	W ---		---		---		---		---	
Back-up Heater		kW ---		---		---		---		---	
Fuse or Circuit Breaker Capacity	A	15		20		15   30		35		45	
<b>Features</b>											
Controls	Microprocessor		Microprocessor		Microprocessor		Microprocessor		Microprocessor		
Low Ambient Control	Equipped		Equipped		Built-in 0°F		Built-in 0°F		Built-in 0°F		
Wireless Remote Controller	included		included		Included		Included		Included		
Wired Remote Controller(optional)	CZ-RD515U & CZ-RC515U		CZ-RD515U & CZ-RC515U		CZ-RTC2		CZ-RD515U & CZ-RC515UA		CZ-RD515U & CZ-RC515UA		
Fan Speeds	Hi / Me / Lo & Auto		Hi / Me / Lo & Auto		Hi / Me / Lo & Auto		Hi / Me / Lo & Auto		Hi / Me / Lo & Auto		
Timer	1hr OFF and 24-hr Program		1hr OFF and 24-hr Program		24-hr Program		1hr OFF and 24-hr Program		1hr OFF and 24-hr Program		
Air Deflection	Horizontal	Manual		Manual		Manual		Manual		Manual	
	Vertical	Automatic		Automatic		Automatic		Automatic		Automatic	
Air Filter	Washable		Washable		Washable		Washable		Washable		
Refrigerant	R-410A		R-410A		R-410A		R-410A		R-410A		
Refrigerant control	Electric Expansion Valve		Electric Expansion Valve		Electric Expansion Valve		Electric Expansion Valve		Electric Expansion Valve		
Operation Sound	In(Hi / Me / Lo/ Qt) dB-A	42 / 38 / 30 / 28		47 / 44 / 41 / 30		48 / 42 / 38		49 / 44 / 39		49 / 44 / 39	
	Outdoor(Hi) dB-A	51		55		49		55		55	
Refrigerant Piping	Type	Flare		Flare		Flare		Flare		Flare	
	Discharge	inches 1/4"		1/4"		3/8"		3/8"		3/8"	
	Suction	inches 1/2"		5/8"		5/8"		5/8"		5/8"	
Refrigerant Pipe Length	Ft.	Max. 100		Max. 132		Max. 165		Max. 164		Max. 164	
Elevation Difference	Outdoor Above	Ft. Max. 50		Max. 50		Max. 100		Max. 100		Max. 100	
	Outdoor Below	Ft. Max. 50		Max. 50		Max. 50		Max. 50		Max. 50	
<b>Dimensions &amp; Weight</b>											
Height	inches	Indoor Unit 11-23/32"	Outdoor Unit 26-3/8"	Indoor Unit 11-23/32"	Outdoor Unit 29-1/8"	Indoor Unit 12-63/64"	Outdoor Unit 30-23/32"	Indoor Unit 11-3/16"	Outdoor Unit 35-13/16"	Indoor Unit 11-3/16"	Outdoor Unit 35-13/16"
	inches	41-15/16"	34-21/32"	41-15/16"	35-7/16"	44-7/8"	37"	41-15/16"	37-1/3"	41-15/16"	37-1/32"
Depth	inches	8-19/32"	11-7/32"	8-19/32"	12-19/32"	8-31/32"	13-3/8"	9-1/16"	13-3/8"	9-1/16"	13-3/8"
Net Weight	Lbs.	26.5	90.4	26.5	119.0	40.0	128.0	32	183	32	183

This is maximum elevation difference when the indoor unit is located above the outdoor unit. (Refer to the table on the P.34 in the catalog for more detail.)

# Wall-Mounted Air Conditioners Standard Models

## S9NKU-1 / S12NKU-1



**Indoor Unit**  
CS-S9NKUW-1 / CS-S12NKUW-1

## S18NKU-1 / S22NKU-1



**Indoor Unit**  
CS-S18NKU-1 / CS-S22NKU-1



**Outdoor Unit**  
CU-S9NKU-1  
CU-S12NKU-1



Wireless  
Remote  
Controller



**Outdoor Unit**  
CU-S18NKU-1  
CU-S22NKU-1



Wireless  
Remote  
Controller



(S18/22 only)

### Wall Mounted Air Conditioners

Model No. Unit Model No.	S9NKU-1		S12NKU-1		S18NKU-1		S22NKU-1	
	Indoor Unit CS-S9NKUW-1	Outdoor Unit CU-S9NKU-1	Indoor Unit CS-S12NKUW-1	Outdoor Unit CU-S12NKU-1	Indoor Unit CS-S18NKU-1	Outdoor Unit CU-S18NKU-1	Indoor Unit CS-S22NKU-1	Outdoor Unit CU-S22NKU-1
<b>Performance &amp; Electrical Ratings</b>								
Capacity	Cooling	Btu/h	8,500(4,100-10,200)		11,900(4,100-13,100)		17,100(4,400-19,800)	
	Heating	Btu/h	---		---		---	
Moisture Removal	High	Pints/H	1.3		2.3		3.6	
Dry Air Flow	High	CFM	400		425		650	
SEER	Cooling		17.5		17.5		17.0	
EER	Cooling		12.1		11.9		10.4	
HSPF	Heating		---		---		---	
Power Supply	V, Phase, Hz		230/208V, 1PH, 60Hz		230/208V, 1PH, 60Hz		230/208V, 1PH, 60Hz	
Running Amps	Cooling	A	3.3/3.7(-4.1)		4.6/5.1(-5.4)		7.5(-9)	
	Heating	A	---		---		---	
Power Input	Cooling	W	700(250-900)		1,000(250-1,150)		1650(250-1950)	
	Heating	W	---		---		---	
Back-up Heater		kW	---		---		---	
Fuse or Circuit Breaker Capacity		A	15		15		20	
<b>Features</b>								
Controls	Microprocessor		Microprocessor		Microprocessor		Microprocessor	
Low Ambient Control	---		---		---		---	
Wireless Remote Controller	Included		Included		Included		Included	
Wired Remote Controller (optional)	CZ-RD516C		CZ-RD516C		CZ-RD516C		CZ-RD516C	
Fan Speeds	5 Speeds + Auto		5 Speeds + Auto		5 Speeds + Auto		5 Speeds + Auto	
Timer	24hr Program		24hr Program		24hr Program		24hr Program	
Air Deflection	Horizontal	Manual	Manual		Automatic		Automatic	
	Vertical	Automatic	Automatic		Automatic		Automatic	
Air Filter	Washable + Anti Microbial Filter		Washable + Anti Microbial Filter		Washable+Anti Microbial Filter		Washable + Anti Microbial Filter	
Refrigerant	R-410A		R-410A		R410A		R-410A	
Refrigerant control	Capillary Tube		Capillary Tube		Electric Expansion Valve		Electric Expansion Valve	
Operation Sound	In(Hi / Lo/ Q-Lo)	dB-A	40 / 25 / 20		43 / 28 / 20		47 / 39 / 36	
	Outdoor(Hi)	dB-A	47		48		50	
Refrigerant Piping	Type		Flare		Flare		Flare	
	Discharge	inches	1/4"		1/4"		1/4"	
	Suction	inches	3/8"		1/2"		5/8"	
Refrigerant Pipe Length		Ft.	Max. 49		Max. 49		Max. 66	
Elevation Difference*	Outdoor Above	Ft.	Max. 16		Max. 16		Max. 49	
	Outdoor Below	Ft.	Max. 16		Max. 16		Max. 49	
<b>Dimensions &amp; Weight</b>								
Height	inches		Indoor Unit	Outdoor Unit	Indoor Unit	Outdoor Unit	Indoor Unit	Outdoor Unit
Width	inches		11-7/16"	21-9/32"	11-7/16"	21-9/32"	11-7/16"	31-5/16"
Depth	inches		34-9/32"	30-23/32"	34-9/32"	30-23/32"	42-5/32"	34-15/32"
Net Weight	Lbs.		8-1/16"	11-13/32"	8-1/16"	11-13/32"	9-9/32"	12-5/8"
			20.0	82.0	20.0	82.0	26.0	115.0
							26.0	117.0

\* This is maximum elevation difference when the indoor unit is located above the outdoor unit. (Refer to the table on the P.34 in the catalog for more detail.)



# Wall-Mounted Air Conditioners Standard Models

## KS18NKU / KS24NKU



**Indoor Unit**  
CS-KS18NKU  
CS-KS24NKU

LIMITED SUPPLY



**Outdoor Unit**  
CU-KS18NKU  
CU-KS24NKU



Wireless Remote Controller  
Wired Remote Controller (optional)



Wall Mounted Air Conditioner

Wall Mounted Air Conditioners					
Model No.	KS18NKU (Limited Supply)			KS24NKU (Limited Supply)	
	Indoor Unit		Outdoor Unit	Indoor Unit	Outdoor Unit
Unit Model No.	CS-KS18NKU		CU-KS18NKU	CS-KS24NKU	CU-KS24NKU
<b>Performance &amp; Electrical Ratings</b>					
Capacity	Cooling	Btu/h	17,500 (4,000-17,500)		24,200 (4,000-24,200)
	Heating	Btu/h	---		---
Moisture Removal	High	Pints/H	4.89		4.89
Dry Air Flow	Hi / Med / Low	CFM	524 / 441 / 377		654 / 571 / 494
SEER	Cooling		20.0		17.0
EER	Cooling		11.7		9.8
HSPF	Heating		---		---
Power Supply	V, Phase, Hz		230 / 208V, 1PH, 60Hz		230 / 208V, 1PH, 60Hz
Running Amps	Cooling	A	7 / 7.7(1.2-7.7)		10.8 / 12.1 (1.3-12.1)
	Heating	A	---		---
Power Input	Cooling	W	1,500 / 1,500(250-1,500)		2,460/ 2,460 (280-2,460)
	Heating	W	---		---
Back-up Heater		kW	---		---
Fuse or Circuit Breaker Capacity		A	15		20
<b>Features</b>					
Controls	Microprocessor			Microprocessor	
Low Ambient Control	---			---	
Wireless Remote Controller	Included			Included	
Wired Remote Controller(optional)	CZ-RD515U & CZ-RC515U			CZ-RD515U & CZ-RC515U	
Fan Speeds	Hi / Me / Lo & Auto			Hi / Me / Lo & Auto	
Timer	1hr OFF and 24-hr Program			1hr OFF and 24-hr Program	
Air Deflection	Horizontal	Manual			Manual
	Vertical	Automatic			Automatic
Air Filter	Washable			Washable	
Refrigerant	R-410A			R-410A	
Refrigerant control	Electric Expansion Valve			Electric Expansion Valve	
Operation Sound	In(Hi / Me / Lo/ Qt) dB-A	42 / 38 / 30 / 28		47 / 44 / 41 / 30	
	Outdoor(Hi)	dB-A		55	
Refrigerant Piping	Type	Flare			Flare
	Discharge	inches	1/4"		1/4"
	Suction	inches	1/2"		5/8"
Refrigerant Pipe Length		Ft.	Max. 100		Max. 131
Elevation Difference*	Outdoor Above	Ft.	Max. 50		Max. 50
	Outdoor Below	Ft.	Max. 50		Max. 50
<b>Dimensions &amp; Weight</b>					
Height	inches	Indoor Unit	11-23/32"	Outdoor Unit	26-3/8"
Width	inches	Indoor Unit	41-15/16"	Outdoor Unit	34-21/32"
Depth	inches	Indoor Unit	8-19/32"	Outdoor Unit	11-7/32"
Net Weight	Lbs.	Indoor Unit	26.5	Outdoor Unit	90.4
		Indoor Unit	26.5	Outdoor Unit	119.0

\* This is maximum elevation difference when the indoor unit is located above the outdoor unit. (Refer to the table on the P.34 in the catalog for more detail.)

# Wall-Mounted Heat Pumps

## E9NKUA / E12NKUA



**Indoor Unit**  
CS-E9NKUAW / CS-E12NKUAW



**Outdoor Unit**  
CU-E9NKUA / CU-E12NKUA



Wireless Remote Controller



Wired Remote Controller (CZ-RD516C) (Optional)

## E18NKUA / E24NKUA



**Indoor Unit**  
CS-E18NKUA / CS-E24NKUA



**Outdoor Unit**  
CU-E18NKUA / CU-E24NKUA



Wireless Remote Controller



Wired Remote Controller (CZ-RD516C) (Optional)



Wall Mounted Heat Pumps									
Model No.	E9NKUA		E12NKUA		E18NKUA		E24NKUA		
Unit Model No.	Indoor Unit	Outdoor Unit	Indoor Unit	Outdoor Unit	Indoor Unit	Outdoor Unit	Indoor Unit	Outdoor Unit	
	CS-E9NKUAW	CU-E9NKUA	CS-E12NKUAW	CU-E12NKUA	CS-E18NKUA	CU-E18NKUA	CS-E24NKUA	CU-E24NKUA	
<b>Performance &amp; Electrical Ratings</b>									
Capacity	Cooling	8,500(4,100-10,200)		12,000(4,100-13,300)		17,100(-)		24,000(-)	
	Heating	11,200(4,100-14,100)		13,800(4,100-16,300)		20,400(-)		28,800(-)	
Moisture Removal	High	1.3		2.5		---		---	
Dry Air Flow	High	395		425		---		---	
SEER	Cooling	21.0		20.0		18.0		17.5	
EER	Cooling	13.1		12.0		13.2		10.2	
HSPF	Heating	10.5		10.6		8.5		8.5	
Power Supply	V, Phase, Hz	230/208V, 1PH, 60Hz		230/208V, 1PH, 60Hz		230/208V, 1PH, 60Hz		230/208V, 1PH, 60Hz	
Running Amps	Cooling	3.1(-7)		4.7(-7.8)		5.95 / 6.60		10.75 / 11.90	
	Heating	5.4(-7)		5.8(-7.8)		7.20 / 8.00		11.40 / 12.60	
Power Input	Cooling	650(250-850)		1,000(250-1,150)		1,300(-)		2,350(-)	
	Heating	1,150(200-1,500)		1,300(200-1,710)		1,600(-)		2,500(-)	
Back-up Heater	kW	---		---		---		---	
Fuse or Circuit Breaker Capacity	A	15		15		20		20	
<b>Features</b>									
Controls	Microprocessor		Microprocessor		Microprocessor		Microprocessor		
Low Ambient Control	Equipped		Equipped		Equipped		Equipped		
Wireless Controller	Included		Included		Included		Included		
Wired Remote Controller(optional)	CZ-RD516C		CZ-RD516C		CZ-RD516C		CZ-RD516C		
Fan Speeds	5 Speeds + Auto		5 Speeds + Auto		5 Speeds + Auto		5 Speeds + Auto		
Timer	24hr Program		24hr Program		24hr Program		24hr Program		
Air Deflection	Horizontal	Manual		Manual		Automatic		Automatic	
	Vertical	Automatic		Automatic		Automatic		Automatic	
Air Filter	Washable + Anti Microbial Filter		Washable + Anti Microbial Filter		Washable + Anti Microbial Filter		Washable + Anti Microbial Filter		
Refrigerant	R-410A		R-410A		R-410A		R-410A		
Refrigerant control	Electric Expansion Valve		Electric Expansion Valve		Electric Expansion Valve		Electric Expansion Valve		
Operation Sound	In(Hi / Me / Lo/ Qt) dB-A	40 / 25 / 20		43 / 28 / 20		---		---	
	Outdoor(Hi) dB-A	47		48		---		---	
Refrigerant Piping	Type	Flare		Flare		Flare		Flare	
	Discharge	1/4"		1/4"		1/4"		1/4"	
	Suction	3/8"		1/2"		1/2"		5/8"	
Refrigerant Pipe Length	Ft.	Max. 66		Max. 66		Max. 100		Max. 100	
Elevation Difference*	Outdoor Above	Ft. Max. 49		Ft. Max. 49		Ft. Max. 49		Ft. Max. 49	
	Outdoor Below	Ft. Max. 49		Ft. Max. 49		Ft. Max. 49		Ft. Max. 49	
<b>Dimensions &amp; Weight</b>									
Height	inches	Indoor Unit 11-7/16"	Outdoor Unit 21-9/32"	Indoor Unit 11-7/16"	Outdoor Unit 21-9/32"	Indoor Unit 11-7/16"	Outdoor Unit 31-5/16"	Indoor Unit 11-7/16"	Outdoor Unit 31-5/16"
Width	inches	34-9/32"	30-23/32"	34-9/32"	30-23/32"	42-5/32"	34-15/32"	42-5/32"	34-15/32"
Depth	inches	8-1/16"	11-13/32"	8-1/16"	11-13/32"	9-9/32"	12-5/8"	9-9/32"	12-5/8"
Net Weight	Lbs.	20.0	82.0	20.0	82.0	26.0	115.0	26.0	117.0

E18/24: Tentative spec.

\* This is maximum elevation difference when the indoor unit is located above the outdoor unit. (Refer to the table on the P.34 in the catalog for more detail.)

# Wall-Mounted Heat Pumps

## KE18NKU / KE24NKU



**Indoor Unit**  
CS-KE18NKU / CS-KE24NKU



**Outdoor Unit**  
CU-KE18NKU / CU-KE24NKU

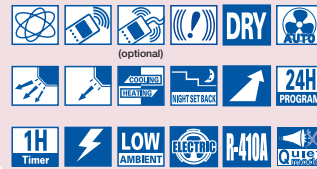

**LIMITED SUPPLY**

Wireless Remote Controller  
Wired Remote Controller (optional)

## 26PEK1U6



**Indoor Unit**  
S-26PK1U6



**Outdoor Unit**  
U-26PE1U6

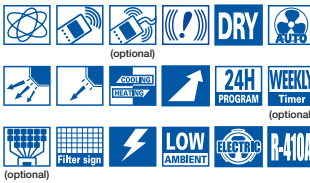

Wireless Remote Controller  
Wired Remote Controller (optional)

## KE30NKU / KE36NKU



**Indoor Unit**  
CS-KE30NKU / CS-KE36NKU



**Outdoor Unit**  
CU-KE30NKU / CU-KE36NKU

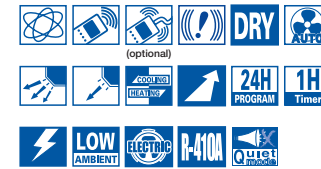

Wireless Remote Controller  
Wired Remote Controller (optional)

Wall Mounted Heat Pumps

Wall Mounted Heat Pumps											
Model No.	KE18NKU (Limited Supply)		KE24NKU (Limited Supply)		26PEK1U6		KE30NKU		KE36NKU		
Unit Model No.	Indoor Unit	Outdoor Unit	Indoor Unit	Outdoor Unit	Indoor Unit	Outdoor Unit	Indoor Unit	Outdoor Unit	Indoor Unit	Outdoor Unit	
	CS-KE18NKU	CU-KE18NKU	CS-KE24NKU	CU-KE24NKU	S-26PK1U6	U-26PE1U6	CS-KE30NKU	CU-KE30NKU	CS-KE36NKU	CU-KE36NKU	
<b>Performance &amp; Electrical Ratings</b>											
Capacity	Cooling Btu/h 17,500 (4,000-17,500)		24,200 (4,000-24,200)		25,200 (9,500-25,200)		30,600 (10,900-30,600)		34,000 (10,900-34,000)		
	Heating Btu/h 20,400 (4,400-20,400)		29,000 (4,400-29,000)		29,200 (8,000-29,200)		33,000 (14,000-33,000)		36,000 (14,000-36,000)		
Moisture Removal	High Pints/H 4.89		4.89		8.1		9.57		10.64		
Dry Air Flow	Hi / Med / Low CFM 524 / 441 / 377		659 / 571 / 494		559 / 475 / 390		630 / 530 / 412		630 / 530 / 412		
SEER	Cooling 20		17		14.9		16		16		
EER	Cooling 11.7		9.8		8.9		9.3		8.5		
HSPF	Heating 10.0		8.5		10.2		9.0		9.0		
Power Supply	V, Phase, Hz 230 / 208V, 1PH, 60Hz		230 / 208V, 1PH, 60Hz		230V / 208V, 1PH, 60Hz		230 / 208V, 1PH, 60Hz		230 / 208V, 1PH, 60Hz		
Running Amps	Cooling A 7 / 7.7 (1.2 ~ 7.7)		10.8 / 12.1 (1.3 ~ 12.1)		15.3 / 16.9		16.5 (5 ~ 16.5) / 18.0		20 (5 ~ 20) / 21.9		
	Heating A 7.4 / 8.1 (1.3 ~ 8.1)		12 / 13.5 (1.3 ~ 13.5)		14.0 / 15.5		15.3 (4.5 ~ 15.3) / 16.3		18.2 (4.5 ~ 18.2) / 19.9		
Power Input	Cooling W 1,500 / 1,500 (250 ~ 1,500)		2,460 / 2,460 (280 ~ 2,460)		2,840 / 2,840		3,290		4,000		
	Heating W 1,575 / 1,575 (270 ~ 1,575)		2,490 / 2,490 (290 ~ 2,490)		2,620 / 2,620		3,070		3,650		
Back-up Heater	kW ---		---		---		---		---		
Fuse or Circuit Breaker Capacity	A 15		20		15   30		35		45		
<b>Features</b>											
Controls	Microprocessor		Microprocessor		Microprocessor		Microprocessor		Microprocessor		
Low Ambient Control	Built-in 0°F		Built-in 0°F		Built-in 0°F		Built-in 0°F		Built-in 0°F		
Wireless Remote Controller	Included		Included		Included		Included		Included		
Wired Remote Controller(optional)	CZ-RD515U & CZ-RC515U		CZ-RD515U & CZ-RC515U		CZ-RTC2		CZ-RD515U & CZ-RC515UA		CZ-RD515U & CZ-RC515UA		
Fan Speeds	Hi / Me / Lo & Auto		Hi / Me / Lo & Auto		3 and Automatic Control / Variable		Hi / Me / Lo & Auto		Hi / Me / Lo & Auto		
Timer	1hr OFF and 24-hr Program		1hr OFF and 24-hr Program		24-hr Program		1hr OFF and 24-hr Program		1hr OFF and 24-hr Program		
Air Deflection	Horizontal	Manual		Manual		---		Manual		Manual	
	Vertical	Automatic		Automatic		Automatic		Automatic		Automatic	
Air Filter	Washable		Washable		Washable		Washable		Washable		
Refrigerant	R-410A		R-410A		R-410A		R-410A		R-410A		
Refrigerant control	Electric Expansion Valve		Electric Expansion Valve		Electric Expansion Valve		Electric Expansion Valve		Electric Expansion Valve		
Operation Sound	In(Hi / Me / Lo/ Qt) dB-A	42 / 38 / 30 / 28		47 / 44 / 41 / 30		41 / 37 / 34		49 / 44 / 39		49 / 44 / 39	
	Outdoor(Hi) dB-A	51	52	55	56	49	55	55	55	55	
Refrigerant Piping	Type	Flare		Flare		Flare		Flare		Flare	
	Discharge inches	1/4"		1/4"		3/8"		3/8"		3/8"	
	Suction inches	1/2"		5/8"		5/8"		5/8"		5/8"	
Refrigerant Pipe Length	Ft.	Max. 100		Max. 100		Max. 165		Max. 164		Max. 164	
Elevation Difference*	Outdoor Above Ft.	Max. 50		Max. 50		Max. 100		Max. 100		Max. 100	
	Outdoor Below Ft.	Max. 50		Max. 50		Max. 50		Max. 50		Max. 50	
<b>Dimensions &amp; Weight</b>											
Height	Indoor Unit inches	11-23/32"		11-23/32"		12-63/64"		11-3/16"		11-3/16"	
	Outdoor Unit inches	26-3/8"		29-1/8"		30-23/32"		35-13/16"		35-13/16"	
Width	Indoor Unit inches	41-15/16"		41-15/16"		44-7/8"		41-15/16"		41-15/16"	
	Outdoor Unit inches	34-21/32"		35-7/16"		37"		37-1/32"		37-1/32"	
Depth	Indoor Unit inches	8-19/32"		8-19/32"		8-31/32"		9-1/16"		9-1/16"	
	Outdoor Unit inches	11-7/32"		12-19/32"		13-3/8"		13-3/8"		13-3/8"	
Net Weight	Lbs.	26.5		26.5		40.0		32.0		185.0	

\* This is maximum elevation difference when the indoor unit is located above the outdoor unit. (Refer to the table on the P.34 in the catalog for more detail.)

# RAC Multi System Indoor Units S/E Series

## Fits with Various Sizes of Room and Life Style

The multi-system type allows a single outdoor unit to be connected to 2 indoor units.

It also solves the problem of limited installation space and does not clutter the exterior of your home.

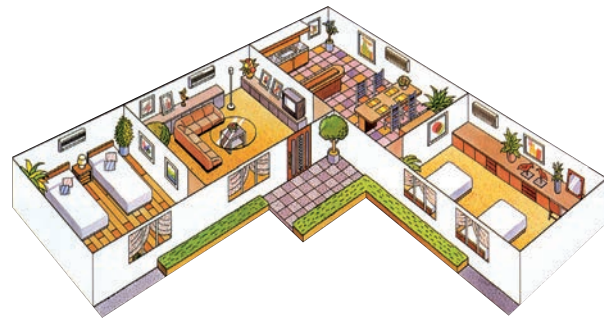

**CS-S9NKUW-1 / CS-S12NKUW-1**  
**CS-E9NKUAW / CS-E12NKUAW**



Wireless Remote Controller "Included" with each indoor



RAC Multi System

## Indoor Unit: Wall Mounted Type

		Cooling Only	
Model No.		CS-S9NKUW-1	CS-S12NKUW-1
Power Source		230V / 208V, 1PH, 60Hz	
Running Ampere	A	4.1 / 4.5	4.7 / 5.2
Power Input	W	850	1,000
Capacity	Cooling Btu/h	9,600	10,900
Moisture Removal	High Pints/H	1.1	1.3
Unit Dimensions (HxWxD)	inch	11-7/16" x 34-9/32" x 8-1/16"	
Net Weight	Lbs.	9.0	9.0
Air Circulation (High)	Cooling CFM	400	425
Operating Sound (H/L)	Cooling dB-A	40 / 25 / 20	43 / 23 / 20
	Heating dB-A	---	---
Refrigerant Tube Diameter	Narrow Tube inch	1/4"	1/4"
	Wide Tube inch	3/8"	3/8"
Elevation Difference*	Outdoor Above Ft.	Max. 49	Max. 49
	Outdoor Below Ft.	Max. 49	Max. 49

		Heat Pump	
Model No.		CS-E9NKUAW	CS-E12NKUAW
Power Source		230V / 208V, 1PH, 60Hz	
Running Ampere		4.1 / 4.5	4.7 / 5.2
Power Input		850 / 1,150	1,000 / 1,300
Capacity	Cooling Btu/h	9,600	10,900
	Heating Btu/h	13,700	15,300
Moisture Removal	High Pints/H	1.1	1.3
Unit Dimensions (HxWxD)	inch	11-7/16" x 34-9/32" x 8-1/16"	
Net Weight	Lbs.	9.0	9.0
Air Circulation (High)	Cooling CFM	395	425
	Heating CFM	430	475
Operating Sound	Cooling dB-A	40 / 25 / 20	43 / 28 / 20
	Heating dB-A	42 / 29 / 26	44 / 35 / 32
Refrigerant Tube Diameter	Narrow Tube inch	1/4"	1/4"
	Wide Tube inch	3/8"	3/8"
Elevation Difference*	Outdoor Above Ft.	Max. 49	Max. 49
	Outdoor Below Ft.	Max. 49	Max. 49

\* This is maximum elevation difference when the indoor unit is located above the outdoor unit. (Refer to the table on the P.34 in the catalog for more detail.)

# RAC Multi System Outdoor Units



For **2** Rooms



CU-2S18NBU-1 / CU-2E18NBU

Model No.	CU-2S18NBU-1		CU-2E18NBU	
<b>Performance</b>	<b>Cooling</b>		<b>Cooling</b>	<b>Heating</b>
Capacity	16,700 Btu/h		16,700	20,200
Air Circulation	High	1,313 CFM	1,313	1,313
Number of Connectable Indoor Units	2		2	2
SEER	Cooling	18.0	18.0	18.0
EER	Cooling	11.5	11.5	11.5
HSPF	Heating	---	8.8	8.8
<b>Electrical Rating</b>				
Power Supply	V, Phase, Hz	230V / 208V, 1PH, 60Hz	230V / 208V, 1PH, 61Hz	
Running Ampere	A	6.9 / 7.6	6.9 / 7.6	8.1 / 9.0
Power Input	W	1,450	1,450	1,850
Maximum Fuse Size	Amps	25	25	25
<b>Features</b>				
Controls	Microprocessor		Microprocessor	
Fan Speeds	Auto		Auto	
Compressor	DC Inverter		DC Inverter	
Refrigerant / Amount Charged at Shipment	R-410A / 67.8 Oz		R-410A / 67.8 Oz	
Refrigerant Control	Electric Expansion Valve		Electric Expansion Valve	
Operation Sound	Hi	48 dB-A	48	49
Refrigerant Tubing Connections	Type	Flare	Flare	
Max. Allowable Tubing Length	Ft.	Max.164 (82' per unit)	Max.164 (82' per unit)	
Refrigerant Tube	Narrow Tube	1/4" inch	1/4" inch	
Diameter	Wide Tube	3/8" inch	3/8" inch	
<b>Dimensions &amp; Weight</b>				
Unit Dimensions	H x W x D	inch	31-5/16" x 34-15/32" (+3-3/4) x 12-5/8"	
Net Weight	Lbs.	152	152	

## CU-2S18NBU-1 & CU-2E18NBU-Cooling

Indoor unit combinations	Cooling Capacity(BTU/h)			Input Power (W)		Current, 208V (A)	Current, 230V (A)	Moisture Removal Volume pt/h		
	Room A	Room B	Total	min - max	Rating					
1 Room	CS-S9NKUW-1 / CS-E9NKUAW	9,600	---	9,600	6,200 ~ 11,200	850	390 ~ 1,020	4.5	4.1	1.1
	CS-S12NKUW-1* / CS-E12NKUAW*	10,900	---	10,900	6,300 ~ 12,800	1,000	390 ~ 1,230	5.2	4.7	1.3
2 Room	CS-S9NKUW-1 / CS-E9NKUAW + CS-S9NKUW-1 / CS-E9NKUAW	8,350	8,350	16,700	7,100 ~ 20,000	1,450	390 ~ 1,920	7.6	6.9	1.1 + 1.1
	CS-S9NKUW-1 / CS-E9NKUAW + CS-S12NKUW-1* + CS-E12NKUAW*	7,800	8,900	16,700	7,200 ~ 20,000	1,450	390 ~ 1,870	7.6	6.9	1.1 + 1.3
	CS-S12NKUW-1* / CS-E12NKUAW* + CS-S12NKUW-1* / CS-E12NKUAW*	8,350	8,350	16,700	7,200 ~ 20,000	1,450	390 ~ 1,840	7.6	6.9	1.3 + 1.3

## CU-2E18NBU-Heating

Indoor unit combinations	Heating Capacity(BTU/h)			Input Power (W)		Current, 208V (A)	Current, 230V (A)	Moisture Removal Volume pt/h		
	Room A	Room B	Total	min - max	Rating					
1 Room	CS-E9NKUAW	13,700	---	13,700	6,400 ~ 15,700	1,150	440 ~ 1,450	5.9	5.4	---
	CS-E12NKUAW	15,300	---	15,300	6,500 ~ 17,500	1,300	440 ~ 1,630	6.6	6.0	---
2 Room	CS-E9NKUAW + CS-E9NKUAW	10,100	10,100	20,200	7,100 ~ 24,600	1,850	420 ~ 2,310	9.0	8.1	---
	CS-E9NKUAW + CS-E12NKUAW*	9,400	10,800	20,200	7,200 ~ 24,600	1,850	420 ~ 2,290	9.0	8.1	---
	CS-E12NKUAW* + CS-E12NKUAW*	10,100	10,100	20,200	7,200 ~ 24,600	1,850	420 ~ 2,290	9.0	8.1	---

\*For CS-S12NKUW-1/CS-E12NKUAW, the pipe size reducer CZ-MA1P must be used when connecting with multi-zone outdoor unit.



# RAC Multi System Indoor Units KS/KE Series

## Fits with Various Sizes of Room and Life Style

The multi-system type allows a single outdoor unit to be connected to 2 to 4 indoor units. It also solves the problem of limited installation space and does not clutter the exterior of your home.

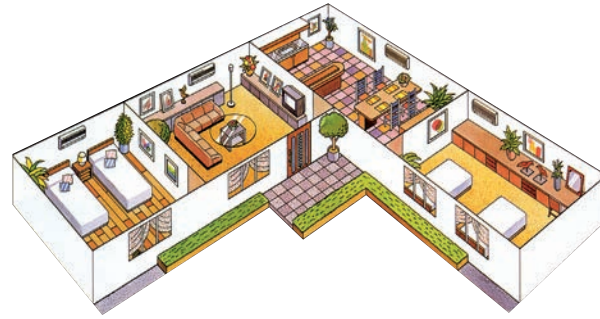

**CS-MKS7NKU / CS-MKS9NKU / CS-MKS12NKU**

**CS-MKS18NKU / CS-MKS24NKU**

**CS-MKE7NKU / CS-MKE9NKU / CS-MKE12NKU**

**CS-MKE18NKU / CS-MKE24NKU**



Wireless Remote Controller (Included) with each indoor

Wired Remote Controller (CZ-RD515U) (optional)



## Indoor Unit: Wall Mounted Type

RAC Multi System

		Cooling Only				
Model No.		CS-MKS7NKU	CS-MKS9NKU	CS-MKS12NKU	CS-MKS18NKU	CS-MKS24NKU
Power Source	A	230V / 208V, 1 PH, 60 Hz				
Running Ampere	W	0.11 / 0.12	0.15 / 0.17	0.15 / 0.17	0.15 / 0.17	0.20 / 0.22
Power Input	W	25	35	35	35	45
Capacity	Cooling Btu/h	7,500	9,000	11,900	17,500	24,200
Moisture Removal	High Pints/H	2.77	3.40	4.26	4.89	4.89
Unit Dimensions (HxWxD)	inch	11"-7/32" x 32"-15/32" x 7"-7/16"			11"-23/32" x 41"-15/16" x 8"-19/32"	
Net Weight	Lbs.	19.8	19.8	19.8	26.5	26.5
Air Circulation (H.M.L)	Cooling CFM	241 / 224 / 212	259 / 241 / 212	282 / 259 / 218	500 / 447 / 377	541 / 500 / 435
Operating Sound (H/L)	Cooling dB-A	33 / 23	34 / 23	36 / 25	41 / 28	44 / 30
	Heating dB-A	---	---	---	---	---
Refrigerant Tube Diameter	Narrow Tube inch	1/4"	1/4"	1/4"	1/4"	1/4"
	Wide Tube inch	3/8"	3/8"	3/8"	1/2"	5/8"
Elevation Difference*	Outdoor Above Ft.	Max. 50	Max. 50	Max. 50	Max. 50	Max. 50
	Outdoor Below Ft.	Max. 50	Max. 50	Max. 50	Max. 50	Max. 50

		Heat Pump				
Model No.		CS-MKE7NKU	CS-MKE9NKU	CS-MKE12NKU	CS-MKE18NKU	CS-MKE24NKU
Power Source	A	230V-208V, 1 PH, 60 Hz				
Running Ampere	W	0.11 / 0.12	0.15 / 0.17	0.15 / 0.17	0.15 / 0.17	0.20 / 0.22
Power Input	W	25	35	35	35	45
Capacity	Cooling Btu/h	7,500	9,000	11,900	17,500	24,200
	Heating Btu/h	8,500	12,200	14,300	20,400	29,000
Moisture Removal	High Pints/H	2.77	3.40	4.26	4.89	4.89
Unit Dimensions (HxWxD)	inch	11"-7/32" x 32"-15/32" x 7"-7/16"			11"-23/32" x 41"-15/16" x 8"-19/32"	
Net Weight	Lbs.	19.8	19.8	19.8	26.5	26.5
Air Circulation (H.M.L)	Cooling CFM	241 / 224 / 212	259 / 249 / 212	282 / 257 / 218	500 / 447 / 377	541 / 500 / 435
	Heating CFM	271 / 241 / 218	282 / 271 / 218	294 / 271 / 218	500 / 447 / 377	541 / 481 / 435
Hi / Me / Lo / Qt	Cooling dB-A	33 / 30 / 27 / 23	34 / 31 / 28 / 23	36 / 33 / 29 / 25	41 / 38 / 34 / 28	44 / 41 / 38 / 30
	Heating dB-A	33 / 30 / 27 / 23	34 / 31 / 28 / 23	34 / 31 / 29 / 25	40 / 37 / 34 / 28	43 / 40 / 37 / 30
Refrigerant Tube Diameter	Narrow Tube inch	1/4"	1/4"	1/4"	1/4"	1/4"
	Wide Tube inch	3/8"	3/8"	3/8"	1/2"	5/8"
Elevation Difference*	Outdoor Above Ft.	Max. 50	Max. 50	Max. 50	Max. 50	Max. 50
	Outdoor Below Ft.	Max. 50	Max. 50	Max. 50	Max. 50	Max. 50

\* This is maximum elevation difference when the indoor unit is located above the outdoor unit. (Refer to the table on the back of the catalog)

# RAC-Multi System Indoor Units KS/KE Series

## Fits with Various Sizes of Room and Life Style

The multi-system type allows a single outdoor unit to be connected to 2 to 4 indoor units. It also solves the problem of limited installation space and does not clutter the exterior of your home.



**CS-MKS9NB4U / CS-MKS12NB4U / CS-KS18NB4UW**

**CS-MKE9NB4U / CS-MKE12NB4U / CS-KE18NB4UW**



Wireless Remote Controller (Included) with each indoor



Wired Remote Controller (CZ-RD515U) (optional)

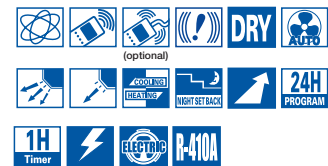

## Indoor Unit: Ceiling Recessed Type

		Cooling Only		
Model No.		CS-MKS9NB4U	CS-MKS12NB4U	CS-KS18NB4UW
<b>Grille Assemblée</b>		CZ-18BT1U		
Power Source		230V / 208V, 1 PH, 60 Hz		
Running Ampere	A	0.10 / 0.11	0.11 / 0.12	0.15 / 0.16
Power Input	W	16	17	22
Capacity	Cooling Btu/h	9,000	11,900	17,500
Moisture Removal	High Pints/H	3.4	4.26	4.89
Unit Dimensions (HxWxD)		12.5"-16" x 24"-19/32" x 24"-19/32"		
Net Weight		41.3		
Air Circulation (H.M.L.)	Cooling CFM	221 / 206 / 194	235 / 206 / 194	341 / 294 / 253
Operating Sound (H/L)	Cooling dB-A	33 / 32 / 31	34 / 32 / 31	44 / 40 / 36
	Heating dB-A	---	---	---
Refrigerant Tube Diameter	Narrow Tube inch	1/4"	1/4"	1/4"
	Wide Tube inch	3/8"	3/8"	3/8"
Elevation Difference*	Outdoor Above Ft.	Max. 50	Max. 50	Max. 50
	Outdoor Below Ft.	Max. 50	Max. 50	Max. 50

		Heat Pump		
Model No.		CS-MKE9NB4U	CS-MKE12NB4U	CS-KE18NB4UW
<b>Grille Assemblée</b>		CZ-18BT1U		
Power Source		230V-208V, 1 PH, 60 Hz		
Running Ampere	A	0.10 / 0.11 & 0.12 / 0.13	0.11 / 0.12 & 0.13 / 0.14	0.15 / 0.16 & 0.19 / 0.20
Power Input	W	16 / 18	17 / 19	22 / 27
Capacity	Cooling Btu/h	9,000	11,900	17,500
	Heating Btu/h	12,300	13,600	20,400
Moisture Removal	High Pints/H	3.4	4.26	4.89
Unit Dimensions (HxWxD)		12.5"-16" x 24"-19/32" x 24"-19/32"		
Net Weight		41.3		
Air Circulation (H.M.L.)	Cooling CFM	221 / 206 / 194	235 / 206 / 194	341 / 294 / 253
Operating Sound(H/L)	Heating CFM	247 / 235 / 224	268 / 247 / 224	383 / 324 / 265
	Cooling dB-A	33 / 32 / 31	34 / 32 / 31	44 / 40 / 36
Refrigerant Tube Diameter	Heating dB-A	34 / 33 / 32	35 / 34 / 32	44 / 40 / 36
	Narrow Tube inch	1/4"	1/4"	1/4"
Elevation Difference*	Wide Tube inch	3/8"	3/8"	1/2"
	Outdoor Above Ft.	Max. 50	Max. 50	Max. 50
	Outdoor Below Ft.	Max. 50	Max. 50	Max. 50

\* This is maximum elevation difference when the indoor unit is located above the outdoor unit. (Refer to the table on the back of the catalog)

RAC Multi System

# RAC Multi System Outdoor Units KS/KE Series

Connectable from 2 to 3 Indoor Units



Up to **3** Rooms



**CU-3KS19NBU**  
**CU-3KE19NBU**

RAC Multi System

## Outdoor Unit

Model No.	CU-3KS19NBU		CU-3KE19NBU	
	Cooling		Cooling	Heating
Capacity	Btu/h	17,000	17,000	23,200
Air Circulation	High CFM	1,707	1,707	1,707
Number of Connectable Indoor Units		2 ~ 3	2 ~ 3	2 ~ 3
SEER	Cooling	18.0	18.0	18.0
EER	Cooling	12.0	12.0	12.0
HSPF	Heating	---	8.8	8.8
<b>Electrical Rating</b>				
Power Supply	V, Phase, Hz	230V / 208V, 1Ph, 60Hz	230V / 208V, 1Ph, 60Hz	
Running Ampere	A	6.3 / 7.0	6.3 / 7.0	9.1 / 10.1
Power Input	W	1,420	1,420	2,050
Maximum Fuse Size	Amps	15A	15A	
<b>Features</b>				
Controls		Microprocessor	Microprocessor	
Fan Speeds		Auto (Hi, Me, Lo)	Auto (Hi, Me, Lo)	
Compressor		DC Inverter	DC Inverter	
Refrigerant / Amount Charged at Shipment	1b.	R-410A / 6.17	R-410A / 6.17	
Refrigerant Control		Electric Expansion Valve	Electric Expansion Valve	
Operation Sound	Hi dB-A	50	50	52
Refrigerant Tubing Connections	Type	Flare	Flare	
Max. Allowable Tubing Length	Ft	82 (per Unit) 150 (per System) with additional refrigerant	82 (per Unit) 150 (per System) with additional refrigerant	
Refrigerant Tube Diameter	Narrow Tube inch	1/4" x 3	1/4" x 3	
	Wide Tube inch	3/8" x 3	3/8" x 3	
<b>Dimensions &amp; Weight</b>				
Unit Dimensions	H x W x D inch	29-1/8" x 35-7/16" x 12-19/32"	29-1/8" x 35-7/16" x 12-19/32"	
Net Weight	Lbs.	138.9	143.0	

**IMPORTANT** It is not possible to connect an outdoor unit to only a single indoor unit. If operated with only ONE indoor unit installed, the returning refrigerant to the compressor may cause a malfunction.

\* Test Conditions based on AHRI 210/240



# RAC Multi System Outdoor Units KS/KE Series



Up to **4** Rooms

Connectable from 3 to 4 Indoor Units



**CU-4KS24NBU**  
**CU-4KE24NBU**



**CU-4KS31NBU**  
**CU-4KE31NBU**

## Outdoor Unit

Model No.		CU-4KS24NBU	CU-4KE24NBU		CU-4KS31NBU	CU-4KE31NBU	
<b>Performance</b>		<b>Cooling</b>	<b>Cooling</b>	<b>Heating</b>	<b>Cooling</b>	<b>Cooling</b>	<b>Heating</b>
Capacity	Btu/h	24,200	22,400	27,200	29,000 / 28,600	29,000 / 28,600	30,600
Air Circulation	High	CFM	1,707	1,707	1,942	1,942	1,942
Number of Connectable Indoor Units		2 ~ 4	2 ~ 4	2 ~ 4	2 ~ 4	2 ~ 4	2 ~ 4
SEER	Cooling	18.0	18.0	18.0	17.6	17.2	17.2
EER	Cooling	10.0	11.5	11.5	11.2	11.2	11.2
HSPF	Heating	---	8.5	8.5	---	9.3	9.3
<b>Electrical Rating</b>							
Power Supply	V, Phase, Hz	230V / 208V, 1Ph, 60Hz	230V / 208V, 1Ph, 60Hz	230V / 208V, 1Ph, 60Hz	230V / 208V, 1Ph, 60Hz	230V / 208V, 1Ph, 60Hz	230V / 208V, 1Ph, 60Hz
Running Ampere	A	10.7 / 11.9	8.7 / 9.6	10.0 / 11.0	11.4 / 12.6	11.4 / 12.6	10.1 / 11.2
Power Input	W	2,420	1,950	2,250	2,600 / 2,560	2,600 / 2,560	2,300
Maximum Fuse Size	Amps	20A	20A	20A	20A	20A	20A
<b>Features</b>							
Controls		Microprocessor	Microprocessor	Microprocessor	Microprocessor	Microprocessor	Microprocessor
Fan Speeds		Auto (Hi, Me, Lo)	Auto (Hi, Me, Lo)	Auto (Hi, Me, Lo)	Auto (Hi, Me, Lo)	Auto (Hi, Me, Lo)	Auto (Hi, Me, Lo)
Compressor		DC Inverter	DC Inverter	DC Inverter	DC Inverter	DC Inverter	DC Inverter
Refrigerant / Amount Charged at Shipment	lb.	R-410A / 6.17	R-410A / 6.17	R-410A / 6.17	R-410A / 8.38	R-410A / 8.38	R-410A / 8.38
Refrigerant Control		Electric Expansion Valve	Electric Expansion Valve	Electric Expansion Valve	Electric Expansion Valve	Electric Expansion Valve	Electric Expansion Valve
Operation Sound	Hi	dB-A	50	52	53	53	55
Refrigerant Tubing Connections	Type	Flare	Flare	Flare	Flare	Flare	Flare
Max. Allowable Tubing Length	Ft	82 (per Unit) 200 (per System with additional Refrigerant)	82 (per Unit) 200 (per System with additional Refrigerant)	82 (per Unit) 200 (per System with additional Refrigerant)	100 (per Unit) 230 (per System with additional Refrigerant)	100 (per Unit) 230 (per System with additional Refrigerant)	100 (per Unit) 230 (per System with additional Refrigerant)
Refrigerant Tube Diameter	Narrow Tube	inch	1/4" x 4	1/4" x 4	1/4" x 4	1/4" x 4	1/4" x 4
	Wide Tube	inch	3/8" x 3 + 1/2" x 1	3/8" x 3 + 1/2" x 1	3/8" x 2 + 1/2" x 2	3/8" x 2 + 1/2" x 2	3/8" x 2 + 1/2" x 2
<b>Dimensions &amp; Weight</b>							
Unit Dimensions	H x W x D	inch	29-1/8" x 35-7/16" x 12-19/32"	29-1/8" x 35-7/16" x 12-19/32"	35-1/32" x 35-7/16" x 12-19/32"	35-1/32" x 35-7/16" x 12-19/32"	35-1/32" x 35-7/16" x 12-19/32"
Net Weight	Lbs.	138.9	143.3	143.3	174.2	174.2	181.0

**IMPORTANT** It is not possible to connect an outdoor unit to only a single indoor unit. If operated with only ONE indoor unit installed, the returning refrigerant to the compressor may cause a malfunction.

\* Test Conditions based on AHRI 210/240

RAC Multi System



# RAC-Multi Combination Tables-Cooling

Most popular combinations, refer to technical manual for complete listing of combinations.

CU-3KS19NBU/CU-3KE19NBU 230V

	Indoor Unit Combination	=	Indoor Unit Capacity (BTU/h)									
			COOLING					HEATING				
			Room A	Room B	Room C	Total Performance			Room A	Room B	Room C	Total Performance
			Capacity	Min.	Max.	Capacity	Min.	Max.	Capacity	Min.	Max.	
2-room Operation	7,500 + 7,500	= 15,000	7,500	7,500		15,000	( 6,800 - 17,400 )	8,500	8,500		17,000	( 6,800 - 21,800 )
	7,500 + 9,000	= 16,500	7,500	9,000		16,500	( 6,800 - 18,600 )	8,525	12,275		20,800	( 7,100 - 24,800 )
	7,500 + 11,900	= 19,400	6,727	10,673		17,400	( 6,800 - 18,600 )	8,358	14,042		22,400	( 7,100 - 24,800 )
	7,500 + 17,500	= 25,000	5,520	12,880		18,400	( 7,100 - 18,600 )	7,000	16,800		23,800	( 8,100 - 24,800 )
	9,000 + 9,000	= 18,000	8,500	8,500		17,000	( 6,800 - 18,600 )	11,600	11,600		23,200	( 7,800 - 24,800 )
	9,000 + 11,900	= 20,900	7,622	10,078		17,700	( 7,100 - 18,600 )	10,800	12,600		23,400	( 7,800 - 24,800 )
	9,000 + 17,500	= 26,500	6,317	12,283		18,600	( 7,100 - 18,600 )	9,075	15,125		24,200	( 8,100 - 24,800 )
	11,900 + 11,900	= 23,800	9,200	9,200		18,400	( 6,800 - 18,600 )	11,900	11,900		23,800	( 7,800 - 24,800 )
11,900 + 17,500	= 29,400	7,529	11,071		18,600	( 7,100 - 18,600 )	10,129	14,471		24,600	( 8,100 - 24,800 )	
3-room Operation	7,500 + 7,500 + 7,500	= 22,500	6,000	6,000	6,000	18,000	( 8,500 - 18,600 )	7,800	7,800	7,800	23,400	( 9,200 - 24,800 )
	7,500 + 7,500 + 9,000	= 24,000	5,750	5,750	6,900	18,400	( 9,800 - 18,600 )	6,919	6,919	9,963	23,800	( 10,200 - 24,800 )
	7,500 + 7,500 + 11,900	= 26,900	5,186	5,186	8,228	18,600	( 9,800 - 18,600 )	6,576	6,578	11,048	24,200	( 10,900 - 24,800 )
	7,500 + 7,500 + 17,500	= 32,500	4,292	4,292	10,015	18,600	( 9,800 - 18,600 )	5,636	5,636	13,527	24,800	( 11,600 - 24,800 )
	7,500 + 9,000 + 9,000	= 25,500	5,471	6,565	6,565	18,600	( 9,800 - 18,600 )	6,237	8,981	8,981	24,200	( 11,600 - 24,800 )
	7,500 + 9,000 + 11,900	= 28,400	4,912	5,894	7,794	18,600	( 9,800 - 18,600 )	5,971	8,598	10,031	24,600	( 11,600 - 24,800 )
	7,500 + 9,000 + 17,500	= 34,000	4,103	4,924	9,574	18,600	( 9,800 - 18,600 )	5,124	7,379	12,298	24,800	( 11,600 - 24,800 )
	7,500 + 11,900 + 11,900	= 31,300	4,457	7,072	7,072	18,600	( 9,800 - 18,600 )	5,688	9,556	9,556	24,800	( 11,600 - 24,800 )
	9,000 + 9,000 + 9,000	= 27,000	6,200	6,200	6,200	18,600	( 9,800 - 18,600 )	8,267	8,267	8,267	24,800	( 11,600 - 24,800 )
	9,000 + 9,000 + 11,900	= 29,900	5,599	5,599	7,403	18,600	( 9,800 - 18,600 )	7,832	7,832	9,137	24,800	( 11,600 - 24,800 )
	9,000 + 11,900 + 11,900	= 32,800	5,104	6,748	6,748	18,600	( 9,800 - 18,600 )	7,440	8,680	8,680	24,800	( 11,600 - 24,800 )
11,900 + 11,900 + 11,900	= 35,700	6,200	6,200	6,200	18,600	( 9,800 - 18,600 )	8,267	8,267	8,267	24,800	( 11,600 - 24,800 )	

CU-4KS24NBU/CU-4KE24NBU

	Indoor Unit Combination	=	Indoor Unit Capacity (BTU/h)											
			COOLING						HEATING					
			Room A	Room B	Room C	Room D	Total Performance			Room A	Room B	Room C	Room D	Total Performance
			Capacity	Min.	Max.	Capacity	Min.	Max.	Capacity	Min.	Max.	Capacity	Min.	Max.
2-room Operation	7,500 + 7,500	= 15,000	7,500	7,500			15,000	( 6,800 - 17,400 )	8,500	8,500			17,000	( 6,800 - 21,800 )
	7,500 + 9,000	= 16,500	7,500	9,000			16,500	( 6,800 - 19,700 )	8,500	12,200			20,800	( 7,100 - 25,400 )
	7,500 + 11,900	= 19,400	7,500	11,900			19,400	( 6,800 - 22,800 )	8,500	14,300			22,800	( 7,100 - 28,200 )
	7,500 + 17,500	= 25,000	6,720	15,680			22,400	( 7,100 - 23,200 )	8,500	20,400			28,200	( 8,100 - 29,200 )
	7,500 + 24,200	= 31,700	5,489	17,711			23,200	( 7,100 - 23,200 )	8,500	29,000			29,200	( 8,100 - 29,200 )
	9,000 + 9,000	= 18,000	9,000	9,000			18,000	( 6,800 - 21,400 )	12,200	12,200			24,400	( 7,800 - 29,000 )
	9,000 + 11,900	= 20,900	8,612	11,388			20,000	( 6,800 - 23,200 )	12,200	14,300			25,800	( 7,800 - 29,000 )
	9,000 + 17,500	= 26,500	7,743	15,057			22,800	( 7,100 - 23,200 )	12,200	20,400			28,600	( 8,100 - 29,200 )
	9,000 + 24,200	= 33,200	6,289	16,911			23,200	( 7,100 - 23,200 )	12,200	29,000			29,200	( 8,100 - 29,200 )
	11,900 + 11,900	= 23,800	11,200	11,200			22,400	( 6,800 - 23,200 )	14,300	14,300			27,200	( 7,800 - 29,000 )
	11,900 + 17,500	= 29,400	9,390	13,810			23,200	( 7,100 - 23,200 )	14,300	20,400			29,000	( 8,100 - 29,200 )
	11,900 + 24,200	= 36,100	7,648	15,552			23,200	( 7,100 - 23,200 )	14,300	29,000			29,200	( 8,100 - 29,200 )
	17,500 + 17,500	= 35,000	11,600	11,600			23,200	( 7,100 - 23,200 )	20,400	20,400			29,200	( 8,100 - 29,200 )
	3-room Operation	7,500 + 7,500 + 7,500	= 22,500	7,333	7,333	7,333		22,000	( 8,500 - 23,200 )	8,500	8,500	8,500		25,400
7,500 + 7,500 + 9,000		= 24,000	7,000	7,000	8,400		22,400	( 9,800 - 23,200 )	8,500	8,500	12,200		27,200	( 10,200 - 29,200 )
7,500 + 7,500 + 11,900		= 26,900	6,413	6,413	10,175		23,000	( 9,800 - 23,200 )	8,500	8,500	14,300		28,200	( 10,900 - 29,200 )
7,500 + 7,500 + 17,500		= 32,500	5,354	5,354	12,492		23,200	( 9,800 - 23,200 )	8,500	8,500	20,400		29,200	( 11,600 - 29,200 )
7,500 + 9,000 + 9,000		= 25,500	6,706	8,047	8,047		22,800	( 9,800 - 23,200 )	8,500	12,200	12,200		28,600	( 11,600 - 29,200 )
7,500 + 9,000 + 11,900		= 28,400	6,127	7,352	9,721		23,200	( 9,800 - 23,200 )	8,500	12,200	14,300		29,000	( 11,600 - 29,200 )
7,500 + 9,000 + 17,500		= 34,000	5,118	6,141	11,941		23,200	( 9,800 - 23,200 )	8,500	12,200	20,400		29,200	( 11,600 - 29,200 )
7,500 + 11,900 + 11,900		= 31,300	5,559	8,820	8,820		23,200	( 9,800 - 23,200 )	8,500	14,300	14,300		29,200	( 11,600 - 29,200 )
7,500 + 11,900 + 17,500		= 36,900	4,715	7,482	11,003		23,200	( 9,800 - 23,200 )	8,500	14,300	20,400		29,200	( 11,600 - 29,200 )
9,000 + 9,000 + 9,000		= 27,000	7,733	7,733	7,733		23,200	( 9,800 - 23,200 )	12,200	12,200	12,200		29,200	( 11,600 - 29,200 )
9,000 + 9,000 + 11,900		= 29,900	6,983	6,983	9,233		23,200	( 9,800 - 23,200 )	12,200	12,200	14,300		29,200	( 11,600 - 29,200 )
9,000 + 9,000 + 17,500		= 35,500	5,882	5,882	11,437		23,200	( 9,800 - 23,200 )	12,200	12,200	20,400		29,200	( 11,600 - 29,200 )
9,000 + 11,900 + 11,900		= 32,800	6,366	8,417	8,417		23,200	( 9,800 - 23,200 )	12,200	14,300	14,300		29,200	( 11,600 - 29,200 )
9,000 + 11,900 + 17,500		= 38,400	5,438	7,190	10,573		23,200	( 9,800 - 23,200 )	12,200	14,300	20,400		29,200	( 11,600 - 29,200 )
11,900 + 11,900 + 11,900		= 35,700	7,733	7,733	7,733		23,200	( 9,800 - 23,200 )	14,300	14,300	14,300		29,200	( 11,600 - 29,200 )
11,900 + 11,900 + 17,500		= 41,300	6,685	6,685	9,831		23,200	( 9,800 - 23,200 )	14,300	14,300	20,400		29,200	( 11,600 - 29,200 )
4-room Operation		7,500 + 7,500 + 7,500 + 7,500	= 30,000	5,800	5,800	5,800	5,800	23,200	( 9,800 - 23,200 )	7,300	7,300	7,300	7,300	29,200
	7,500 + 7,500 + 7,500 + 9,000	= 31,500	5,524	5,524	5,524	6,629	23,200	( 9,800 - 23,200 )	6,952	6,952	6,952	8,343	29,200	( 11,600 - 29,200 )
	7,500 + 7,500 + 7,500 + 11,900	= 34,400	5,058	5,058	5,058	8,026	23,200	( 9,800 - 23,200 )	6,366	6,366	6,366	10,101	29,200	( 11,600 - 29,200 )
	7,500 + 7,500 + 7,500 + 17,500	= 40,000	4,350	4,350	4,350	10,150	23,200	( 9,800 - 23,200 )	5,475	5,475	5,475	12,775	29,200	( 11,600 - 29,200 )
	7,500 + 7,500 + 9,000 + 9,000	= 33,000	5,273	5,273	6,327	6,327	23,200	( 9,800 - 23,200 )	6,636	6,636	7,964	7,964	29,200	( 11,600 - 29,200 )
	7,500 + 7,500 + 9,000 + 11,900	= 35,900	4,847	4,847	5,816	7,690	23,200	( 9,800 - 23,200 )	6,100	6,100	7,320	9,679	29,200	( 11,600 - 29,200 )
	7,500 + 7,500 + 9,000 + 17,500	= 41,500	4,193	4,193	5,031	9,783	23,200	( 9,800 - 23,200 )	5,277	5,277	6,333	12,313	29,200	( 11,600 - 29,200 )
	7,500 + 7,500 + 11,900 + 11,900	= 38,800	4,485	4,485	7,115	7,115	23,200	( 9,800 - 23,200 )	5,644	5,644	8,956	8,956	29,200	( 11,600 - 29,200 )
	7,500 + 7,500 + 11,900 + 17,500	= 44,400	3,919	3,919	6,218	9,144	23,200	( 9,800 - 23,200 )	4,932	4,932	7,826	11,509	29,200	( 11,600 - 29,200 )
	7,500 + 9,000 + 9,000 + 9,000	= 34,500	5,043	6,052	6,052	6,052	23,200	( 9,800 - 23,200 )	6,348	7,617	7,617	7,617	29,200	( 11,600 - 29,200 )
	7,500 + 9,000 + 9,000 + 11,900	= 37,400	4,652	5,583	5,583	7,382	23,200	( 9,800 - 23,200 )	5,856	7,027	7,027	9,291	29,200	( 11,600 - 29,200 )
	7,500 + 9,000 + 9,000 + 17,500	= 43,000	4,047	4,856	4,856	9,442	23,200	( 9,800 - 23,200 )	5,093	6,112	6,112	11,884	29,200	( 11,600 - 29,200 )
	7,500 + 9,000 + 11,900 + 11,900	= 40,300	4,318	5,181	6,851	6,851								

CU-4KS31NBU/CU-4KE31NBU 230V

	Indoor Unit Combination		Indoor Unit Capacity (BTU/h)																		
			COOLING						HEATING												
			Room A	Room B	Room C	Room D	Total Performance			Room A	Room B	Room C	Room D	Total Performance							
		Capacity	( Min.	-	Max. )	Capacity	( Min.	-	Max. )	Capacity	( Min.	-	Max. )								
2-room Operation	7500 + 7,500	= 15,000	7,500	7,500			15,000	( 4,400	-	17,400 )	8,500	8,500			17,000	( 6,800	-	21,800 )			
	7500 + 9,000	= 16,500	7,500	9,000			16,500	( 5,100	-	19,700 )	8,541	12,259			20,800	( 7,100	-	25,400 )			
	7500 + 11,900	= 19,400	7,500	11,900			19,400	( 5,800	-	22,800 )	8,500	14,300			22,800	( 7,800	-	28,200 )			
	7500 + 17,500	= 25,000	7,320	17,080			24,400	( 7,500	-	26,200 )	8,529	20,471			29,000	( 10,200	-	32,000 )			
	7500 + 24,200	= 31,700	6,625	21,375			28,000	( 7,800	-	30,000 )	6,800	23,200			30,000	( 10,200	-	32,000 )			
	9000 + 9,000	= 18,000	9,000	9,000			18,000	( 5,800	-	22,000 )	12,200	12,200			24,400	( 8,100	-	29,000 )			
	9000 + 11,900	= 20,900	8,957	11,843			20,800	( 6,400	-	25,200 )	11,878	13,922			25,800	( 8,800	-	29,000 )			
	9000 + 17,500	= 26,500	8,626	16,774			25,400	( 7,800	-	29,000 )	11,002	18,398			29,400	( 11,200	-	32,000 )			
	9000 + 24,200	= 33,200	7,861	21,139			29,000	( 7,800	-	30,000 )	9,061	21,539			30,600	( 11,200	-	32,000 )			
	11900 + 11,900	= 23,800	11,900	11,900			23,800	( 7,500	-	28,600 )	13,600	13,600			27,200	( 9,800	-	29,000 )			
	11900 + 17,500	= 29,400	10,848	15,952			26,800	( 8,800	-	30,000 )	12,281	17,519			29,800	( 11,600	-	32,000 )			
	11900 + 24,200	= 36,100	9,625	19,575			29,200	( 8,800	-	30,000 )	10,238	20,762			31,000	( 11,600	-	32,000 )			
	17500 + 17,500	= 35,000	14,500	14,500			29,000	( 8,800	-	30,000 )	15,300	15,300			30,600	( 11,600	-	32,000 )			
	17500 + 24,200	= 41,700	12,296	17,004			29,300	( 9,200	-	30,000 )	13,215	18,785			32,000	( 11,600	-	32,000 )			
	3-room Operation	7500 + 7,500 + 7,500	= 22,500	7,467	7,467	7,467			22,400	( 6,800	-	26,200 )	8,467	8,467	8,467		25,400	( 9,200	-	30,600 )	
7500 + 7,500 + 9,000		= 24,000	7,500	7,500	9,000			24,000	( 7,500	-	26,600 )	8,442	8,442	12,116		29,000	( 10,200	-	31,200 )		
7500 + 7,500 + 11,900		= 26,900	7,082	7,082	11,236			25,400	( 8,100	-	26,800 )	7,930	7,930	13,341		29,200	( 10,900	-	32,000 )		
7500 + 7,500 + 17,500		= 32,500	6,600	6,600	15,400			28,600	( 9,200	-	30,600 )	6,818	6,818	16,364		30,000	( 11,600	-	32,000 )		
7500 + 7,500 + 24,200		= 39,200	5,587	5,587	18,027			29,200	( 9,800	-	30,600 )	5,802	5,802	19,796		31,400	( 11,600	-	32,000 )		
7500 + 9,000 + 9,000		= 25,500	7,294	8,753	8,753			24,800	( 7,800	-	27,200 )	7,596	10,902	10,902		29,400	( 11,200	-	31,600 )		
7500 + 9,000 + 11,900		= 28,400	6,972	8,366	11,062			26,400	( 8,800	-	27,600 )	7,237	10,387	12,175		29,800	( 11,600	-	32,000 )		
7500 + 9,000 + 17,500		= 34,000	6,309	7,571	14,721			28,600	( 9,800	-	30,600 )	6,328	9,083	15,188		30,600	( 11,600	-	32,000 )		
7500 + 9,000 + 24,200		= 40,700	5,381	6,457	17,362			29,200	( 9,800	-	30,600 )	5,473	7,855	18,672		32,000	( 11,600	-	32,000 )		
7500 + 11,900 + 11,900		= 31,300	6,613	10,493	10,493			27,600	( 9,200	-	28,600 )	6,873	11,563	11,563		30,000	( 11,600	-	32,000 )		
7500 + 11,900 + 17,500		= 36,900	5,935	9,417	13,848			29,200	( 9,800	-	30,600 )	6,100	10,262	14,639		31,000	( 11,600	-	32,000 )		
7500 + 11,900 + 24,200		= 43,600	5,023	7,970	16,207			29,200	( 9,800	-	30,600 )	5,251	8,834	17,915		32,000	( 11,600	-	32,000 )		
7500 + 17,500 + 17,500		= 42,500	5,153	12,024	12,024			29,200	( 9,800	-	30,600 )	5,517	13,241	13,241		32,000	( 11,600	-	32,000 )		
7500 + 17,500 + 24,200		= 49,200	4,451	10,386	14,363			29,200	( 9,800	-	30,600 )	4,698	11,275	16,028		32,000	( 11,600	-	32,000 )		
9000 + 9,000 + 9,000		= 27,000	8,533	8,533	8,533			25,600	( 8,500	-	27,200 )	10,000	10,000	10,000		30,000	( 11,600	-	32,000 )		
9000 + 9,000 + 11,900		= 29,900	8,187	8,187	10,825			27,200	( 9,200	-	28,200 )	9,520	9,520	11,159		30,200	( 11,600	-	32,000 )		
9000 + 9,000 + 17,500		= 35,500	7,352	7,352	14,296			29,000	( 9,800	-	30,600 )	8,496	8,496	14,207		31,200	( 11,600	-	32,000 )		
9000 + 9,000 + 24,200		= 42,200	6,185	6,185	16,630			29,000	( 9,800	-	30,600 )	7,311	7,311	17,378		32,000	( 11,600	-	32,000 )		
9000 + 11,900 + 11,900		= 32,800	7,848	10,376	10,376			28,600	( 9,200	-	29,200 )	9,150	10,725	10,725		30,600	( 11,600	-	32,000 )		
9000 + 11,900 + 17,500		= 38,400	6,844	9,049	13,307			29,200	( 9,800	-	30,600 )	8,220	9,635	13,745		31,600	( 11,600	-	32,000 )		
9000 + 11,900 + 24,200		= 45,100	5,827	7,705	15,668			29,200	( 9,800	-	30,600 )	7,034	8,245	16,721		32,000	( 11,600	-	32,000 )		
9000 + 17,500 + 17,500		= 44,000	5,973	11,614	11,614			29,200	( 9,800	-	30,600 )	7,366	12,317	12,317		32,000	( 11,600	-	32,000 )		
11900 + 11,900 + 11,900		= 35,700	9,267	9,267	9,267			27,800	( 9,800	-	29,000 )	10,333	10,333	10,333		31,000	( 11,600	-	32,000 )		
11900 + 11,900 + 17,500		= 41,300	8,414	8,414	12,373			29,200	( 9,800	-	30,600 )	9,280	9,280	13,239		31,800	( 11,600	-	32,000 )		
11900 + 11,900 + 24,200		= 48,000	7,239	7,239	14,722			29,200	( 9,800	-	30,600 )	7,944	7,944	16,111		32,000	( 11,600	-	32,000 )		
11900 + 17,500 + 17,500		= 46,900	7,409	10,896	10,896			29,200	( 9,800	-	30,600 )	8,305	11,848	11,848		32,000	( 11,600	-	32,000 )		
4-room Operation		7500 + 7,500 + 7,500 + 7,500	= 30,000	7,050	7,050	7,050	7,050			28,200	( 9,800	-	28,200 )	7,400	7,400	7,400	7,400		29,600	( 11,600	-
	7500 + 7,500 + 7,500 + 9,000	= 31,500	6,905	6,905	6,905	8,286			29,000	( 9,800	-	29,000 )	6,899	6,899	6,899	9,903		30,600	( 11,600	-	32,000 )
	7500 + 7,500 + 7,500 + 11,900	= 34,400	6,453	6,453	6,453	10,240			29,600	( 9,800	-	29,600 )	6,577	6,577	6,577	11,069		30,800	( 11,600	-	32,000 )
	7500 + 7,500 + 7,500 + 17,500	= 40,000	5,738	5,738	5,738	13,388			30,600	( 9,800	-	30,600 )	5,815	5,815	5,815	13,956		31,400	( 11,600	-	32,000 )
	7500 + 7,500 + 7,500 + 24,200	= 46,700	4,914	4,914	4,914	15,857			30,600	( 9,800	-	30,600 )	4,991	4,991	4,991	17,028		32,000	( 11,600	-	32,000 )
	7500 + 7,500 + 9,000 + 9,000	= 33,000	6,636	6,636	7,964	7,964			29,200	( 9,800	-	29,200 )	6,324	6,324	9,076	9,076		30,800	( 11,600	-	32,000 )
	7500 + 7,500 + 9,000 + 11,900	= 35,900	6,267	6,267	7,521	9,944			30,000	( 9,800	-	30,000 )	6,097	6,097	8,750	10,257		31,200	( 11,600	-	32,000 )
	7500 + 7,500 + 9,000 + 17,500	= 41,500	5,530	5,530	6,636	12,904			30,600	( 9,800	-	30,600 )	5,484	5,484	7,871	13,161		32,000	( 11,600	-	32,000 )
	7500 + 7,500 + 9,000 + 24,200	= 48,200	4,761	4,761	5,714	15,363			30,600	( 9,800	-	30,600 )	4,674	4,674	6,708	15,945		32,000	( 11,600	-	32,000 )
	7500 + 7,500 + 11,900 + 11,900	= 38,800	5,915	5,915	9,385	9,385			30,600	( 9,800	-	30,600 )	5,816	5,816	9,784	9,784		31,200	( 11,600	-	32,000 )
	7500 + 7,500 + 11,900 + 17,500	= 44,400	5,169	5,169	8,201	12,061			30,600	( 9,800	-	30,600 )	5,261	5,261	8,851	12,627		32,000	( 11,600	-	32,000 )
	7500 + 7,500 + 17,500 + 17,500	= 50,000	4,590	4,590	10,710	10,710			30,600	( 9,800	-	30,600 )	4,706	4,706	11,294	11,294		32,000	( 11,600	-	32,000 )
	7500 + 9,000 + 9,000 + 9,000	= 34,500	6,217	7,461	7,461	7,461			28,600	( 9,800	-	28,600 )	5,880	8,440	8,440	8,440		31,200	( 11,600	-	32,000 )
	7500 + 9,000 + 9,000 + 11,900	= 37,400	6,136	7,364	7,364	9,736			30,600	( 9,800	-	30,600 )	5,691	8,168	8,168	9,574		31,600	( 11,600	-	32,000 )
	7500 + 9,000 + 9,000 + 17,500	= 43,000	5,337	6,405	6,405	12,453			30,600	( 9,800	-	30,600 )	5,103	7,325	7,325	12,248		32,000	( 11,600	-	32,000 )
	7500 + 9,000 + 11,																				

# Ceiling-Suspended Air Conditioners & Heat Pumps

26PST1U6

26PET1U6



Indoor Unit  
S-26PT1U6

36PST1U6 / 42PST1U6

36PET1U6 / 42PET1U6



Indoor Unit  
S-36PT1U6 / S-42PT1U6



Outdoor Unit  
U-26PS1U6 / U-26PE1U6



Wired Remote Controller  
(CZ-RTC2)(Included)  
Wireless Remote Controller  
(optional)



Outdoor Unit  
U-36PS1U6 / U-36PE1U6



Outdoor Unit  
U-42PS1U6 / U-42PE1U6



Wired Remote Controller  
(CZ-RTC2)(Included)  
Wireless Remote Controller  
(optional)

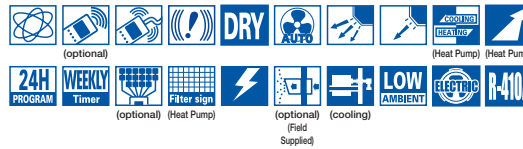

Ceiling Suspended Air Conditioners & Heat Pumps

## Quiet Operation

The ceiling-mounted unit is equipped with a highly efficient, multi-blade centrifugal fan that generates a powerful yet gentle airflow throughout the room. A redesigned aerodynamically tested louver structure minimizes operational sound even at high fan speed.



## Improved Serviceability / Easy Installation

External suspension method. Installation time can be shortened.

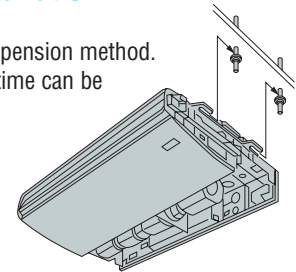

Improved accessibility to electronic components (control box) for servicing.



## Auto Louver Function Provides Optimum Airflow During Heating or Cooling Operation

Auto louver function is a standard feature which provides optimum airflow during heating or cooling operation. Angle of louver is automatically set for heating or cooling. For example, when heating with fan speed set to low, the discharge is aimed downward so that warm air reaches the floor. The louver angle can be set to between 4° above and 80° below the horizontal in five steps. An auto sweep function to distribute the airflow over a wide area is also provided.

Wind direction is adjusted automatically in both heating and cooling operation. The louver can also be set to swing automatically from F1 to F5 in any operation mode (heat pump type only).

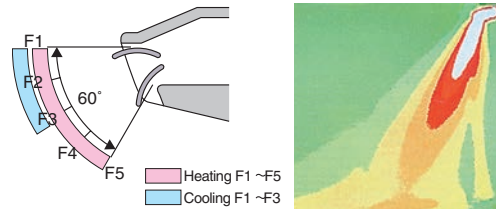

## Fresh Air Intake Capability & Duct Extension

Ceiling Suspended models (T1-series) have the capability of bringing fresh air from outside using an air intake duct (field supplied).

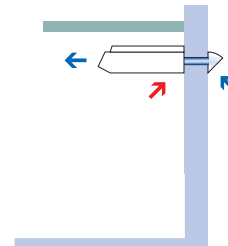

Ceiling - Suspended													
Model No.	Air Conditioners						Heat Pumps						
	26PST1U6		36PST1U6		42PST1U6		26PET1U6		36PET1U6		42PET1U6		
Unit Model No.	Indoor Unit	Outdoor Unit	Indoor Unit	Outdoor Unit	Indoor Unit	Outdoor Unit	Indoor Unit	Outdoor Unit	Indoor Unit	Outdoor Unit	Indoor Unit	Outdoor Unit	
	S-26PT1U6	U-26PS1U6	S-36PT1U6	C-36PS1U6	S-42PT1U6	U-42PS1U6	S-26PT1U6	U-26PE1U6	S-36PT1U6	U-36PE1U6	S-42PT1U6	U-42PE1U6	
<b>Performance &amp; Electrical Ratings</b>													
Capacity	Cooling	24,400 (9,500-24,400)		31,200 (9,500-31,200)		39,000 (9,500-39,000)		24,400 (9,500-24,400)		31,200 (9,500-31,200)		39,000 (9,500-39,000)	
	Heating	---		---		---		30,800 (8,000-30,800)		37,400 (8,000-37,400)		44,500 (8,000-44,500)	
Moisture Removal	High	7.7		10.0		12.6		7.7		10.0		12.6	
Dry Air Flow	Hi / Med / Low	550 / 490 / 460		1,100 / 930 / 750		1,130 / 950 / 775		550 / 490 / 460		1,100 / 930 / 750		1,130 / 950 / 775	
SEER	Cooling	14.5		15.1		15.6		14.5		15.1		15.6	
EER	Cooling	8.5		8.10		9.4		8.5		8.10		9.4	
HSPF	Heating	---		---		---		9.4		8.8		9.5	
Power Supply	V, Phase, Hz	230 / 208 / 1 / 60		230 / 208 / 1 / 60		230 / 208 / 1 / 60		230 / 208 / 1 / 60		230 / 208 / 1 / 60		230 / 208 / 1 / 60	
Running Amps	Cooling	15.6 / 17.3		18.2 / 20.1		21.1 / 23.3		15.6 / 17.3		18.2 / 20.1		21.1 / 23.3	
	Heating	---		---		---		16.4 / 18.1		15.6 / 17.3		18.6 / 20.6	
Power Input	Cooling	2,880 / 2,880		3,840 / 3,840		4,140 / 4,140		2,880 / 2,880		3,840 / 3,840		4,140 / 4,140	
	Heating	---		---		---		3,000 / 3,000		3,250 / 3,250		3,630 / 3,630	
Fuse or Circuit Breaker Capacity	A	15	30	15	35	15	40	15	30	15	35	15	40
<b>Features</b>													
Controls	Microprocessor												
Low Ambient Control (for Cooling)	Built-in 0°F												
Wireless Remote Controller (optional)	CZ-RWSU2U, CZ-RWSC1U												
Wired Remote Controller (included)	CZ-RTC2												
Fan Speeds	3 and Automatic Control / Variable												
Timer	7 Days/6 Events												
Air Deflection	Horizontal	---											
	Vertical	Automatic											
Air Filter	Washable												
Refrigerant	R-410A												
Refrigerant control	Electric Expansion Valve												
Operation Sound	In(Hi / Me / Lo) dB-A	39 / 37 / 33		42 / 40 / 35		44 / 41 / 37		39 / 37 / 33		42 / 40 / 35		44 / 41 / 37	
	Outdoor(Hi) dB-A	49		52		53		49		52		53	
Refrigerant Piping	Type	Flare											
	Discharge	3/8"		3/8"		3/8"		3/8"		3/8"		3/8"	
	Suction	5/8"		5/8"		5/8"		5/8"		5/8"		5/8"	
Refrigerant Pipe Length	Ft.	Max. 165		Max. 165		Max. 165		Max. 165		Max. 165		Max. 165	
Elevation Difference*	Outdoor Above	Ft. Max. 100											
	Outdoor Below	Ft. Max. 50											
<b>Dimensions &amp; Weight</b>													
Height	inches	7-17/32"	30-23/32"	9-7/16"	30-23/32"	9-7/16"	48-7/16"	7-17/32"	30-23/32"	9-7/16"	30-23/32"	9-7/16"	48-7/16"
Width	inches	51-3/16"	37"	62-1/32"	37"	62-1/32"	37"	51-3/16"	37"	62-1/32"	37"	62-1/32"	37"
Depth	inches	26-3/8"	13-3/8"	26-3/8"	3-3/8"	26-3/8"	13-3/8"	26-3/8"	13-3/8"	26-3/8"	13-3/8"	26-3/8"	13-3/8"
Net Weight	Lbs.	57.0	128.0	84.0	143.0	84.0	220.0	57.0	128.0	84.0	143.0	84.0	220.0

\* This is maximum elevation difference when the indoor unit is located above the outdoor unit. (Refer to the table on the back of the catalog)

# Ceiling-Recessed Air Conditioners & Heat Pumps

KS12NB41A / KS18NB4U / KS18NB4UA

KE12NB41 / KE18NB4U

**Indoor Unit**  
CS-KS12NB41  
CS-KS18NB4UW  
CS-KE12NB41  
CS-KE18NB4UW

**Grille Assembly**  
CZ-18BT1U



Wireless Remote Controller (Included)

Wired Remote Controller (CZ-RD515U) (optional)



**Outdoor Unit**  
CU-KS12NK1A  
CU-KE12NK1



**Outdoor Unit**  
CU-KS18NKU  
CU-KS18NKUA  
CU-KE18NKU



26PSU1U6

26PEU1U6

**Indoor Unit**  
S-26PU1U6

**Grille Assembly**  
CZ-24KPU1U



36PSU1U6 / 42PSU1U6

36PEU1U6 / 42PEU1U6

**Indoor Unit**  
S-36PU1U6 / S-42PU1U6

**Grille Assembly**  
CZ-36KPU1U



**Outdoor Unit**  
U-26PS1U6  
U-26PE1U6



Wired Remote Controller (CZ-RTC2) (Included)

Wireless Remote Controller (optional)



**Outdoor Unit**  
U-36PS1U6  
U-36PE1U6



**Outdoor Unit**  
U-42PS1U6  
U-42PE1U6



Wired Remote Controller (CZ-RTC2) (Included)

Wireless Remote Controller (optional)



Ceiling Suspended Air Conditioners & Heat Pumps

## 4-Way Airflow Design Sends Cool Air in all Directions

Air is returned through the center of the grille, while evenly distributing air through each of the 4 supply air openings. Installation in the center of the room provides for the greatest comfort. However, 1 or 2 supply louvers can be closed for installation near 1 wall to provide 3 or 2 way airflow. Also, by closing off 1 supply louver, you may attach a duct (field supply) to the upper plenum and provide conditioned air to another, separate area.

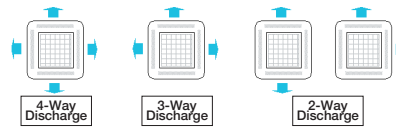
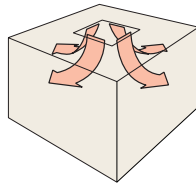

## Integrated Drain Pump

Drain pump is built into the unit to raise the condensate up 20 inches from the drain pump discharge.

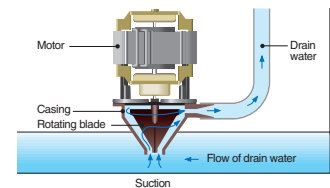

## Fresh Air Intake Plenum (Option)

When used to take in fresh air, attach the fresh air-intake plenum to the unit.

Air-intake plenum is optionally supplied.

CZ-26BCU1U for S-26PU1U6  
CZ-42BCU1U for S-36/42PU1U6

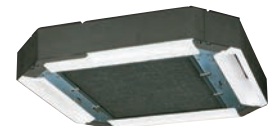

## Whisper-Quiet Operation

Thanks to the newly developed turbo fan and decreased resistance of the air path, one of the industry's lowest levels of noise has been achieved.

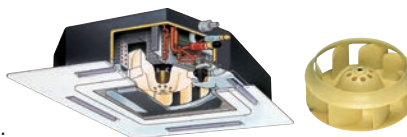

Ceiling - Recessed			Air Conditioners						Heat Pumps			
Model No.	KS12NB41A		KS18NB4U		KS18NB4UA		KE12NB41		KE18NB4U			
Unit Model No.	Indoor Unit	Outdoor Unit	Indoor Unit	Outdoor Unit	Indoor Unit	Outdoor Unit	Indoor Unit	Outdoor Unit	Indoor Unit	Outdoor Unit		
	CS-KS12NB41	CU-KS12NK1A	CS-KS18NB4UW	CU-KS18NKU	CS-KS18NB4UW	CU-KS18NKUA	CS-KE12NB41	CU-KE12NK1	CS-KE18NB4UW	CU-KE18NKU		
Grille Assembly	CZ-18BT1U		CZ-18BT1U		CZ-18BT1U		CZ-18BT1U		CZ-18BT1U			
<b>Performance &amp; Electrical Ratings</b>												
Capacity	Cooling	Btu/h	11,900 (3,000 ~ 11,900)		17,500 (4,000 ~ 17,500)		17,500 (4,000 ~ 17,500)		11,900 (3,000 ~ 11,900)		17,500 (4,000 ~ 17,500)	
	Heating	Btu/h	---		---		---		13,600 (3,000 ~ 13,600)		20,400 (4,400 ~ 20,400)	
Moisture Removal	High	Pints/H	4.26		4.89		4.89		4.26		4.89	
Dry Air Flow	Hi / Med / Low	CFM	235 / 206 / 194		341 / 294 / 253		341 / 294 / 253		235 / 206 / 194		341 / 294 / 253	
SEER	Cooling	Btu/Wh	16		16		16		16		16	
EER	Cooling	Btu/Wh	9.4		9.41		9.41		9.4		9.4	
HSPF	Heating	Btu/Wh	---		---		---		8.5		8.5	
Power Supply	V, Phase, Hz		115V, Single phase, 60Hz		208 / 230V, Single phase, 60Hz		208 / 230V, Single phase, 60Hz		115V, Single phase, 60Hz		208 / 230V, Single phase, 60Hz	
Running Amps	Cooling	A	12.6 (2.5-12.6)		8.3 (1.2-8.3)		8.3 (1.2-8.3)		12.6 (2.5-12.6)		8.3 (1.2-8.3)	
	Heating	A	---		---		---		14.6 (2.5-14.6)		10.5 (1.3-10.5)	
Power Input	Cooling	W	1,260 (250-1,260)		1,860 (250-1,860)		1,860 (250-1,860)		1,260 (250-1,260)		1,860 (250-1,860)	
	Heating	W	---		---		---		1,460 (250-1,460)		2,340 (270-2,340)	
Fuse or Circuit Breaker Capacity	A		20		20		20		20		20	
<b>Features</b>												
Controls	Microprocessor		Microprocessor		Microprocessor		Microprocessor		Microprocessor		Microprocessor	
Low Ambient Control (for Cooling)	Equipped		n/a		Equipped		Equipped		Equipped		Equipped	
Wireless Remote Controller	Included		Included		Included		Included		Included		Included	
Wired Remote Controller(optional)	CZ-RD515U		CZ-RD515U		CZ-RD515U		CZ-RD515U		CZ-RD515U		CZ-RD515U	
Fan Speeds	Hi/Me/Lo & Auto		Hi/Me/Lo & Auto		Hi/Me/Lo & Auto		Hi/Me/Lo & Auto		Hi/Me/Lo & Auto		Hi/Me/Lo & Auto	
Timer	1 hr OFF and 24-hr PROGRAM		1 hr OFF and 24-hr PROGRAM		1 hr OFF and 24-hr PROGRAM		1 hr OFF and 24-hr PROGRAM		1 hr OFF and 24-hr PROGRAM		1 hr OFF and 24-hr PROGRAM	
Air Deflection	Horizontal		---		---		---		---		---	
	Vertical		Automatic		Automatic		Automatic		Microprocessor		Automatic	
Air Filter	Washable		Washable		Washable		Washable		Washable		Washable	
Refrigerant	R-410A		R-410A		R-410A		R-410A		R-410A		R-410A	
Refrigerant Control	Electric Expansion Valve		Electric Expansion Valve		Electric Expansion Valve		Electric Expansion Valve		Electric Expansion Valve		Electric Expansion Valve	
Operation Sound	In(Hi / Me / Lo)	dB-A	34 / 32 / 31		44 / 40 / 36		44 / 40 / 36		34 / 32 / 31		44 / 40 / 36	
	Outdoor(Hi)	dB-A	47		47		47		51		51	
Refrigerant Piping (Cooling)	Type		Flare		Flare		Flare		Flare		Flare	
	Discharge	inches	1/4"		1/4"		1/4"		1/4"		1/4"	
	Suction	inches	3/8"		1/2"		1/2"		3/8"		1/2"	
Refrigerant Pipe Length		Ft.	65		98		98		65		98	
Elevation Difference*	Outdoor Above	Ft.	23		50		50		23		50	
	Outdoor Below	Ft.	23		50		50		23		50	
<b>Dimensions &amp; Weight</b>												
Height	inches		12-5/16"	21-9/16"	12-5/16"	26-3/8"	12-5/16"	26-3/8"	12-5/16"	21-9/16"	12-5/16"	26-3/8"
Width	inches		24-19/32"	28-11/32"	24-19/32"	34-21/32"	24-19/32"	34-21/32"	24-19/32"	28-11/32"	24-19/32"	34-21/32"
Depth	inches		24-19/32"	10-7/16"	24-19/32"	11-7/32"	24-19/32"	11-7/32"	24-19/32"	10-7/16"	24-19/32"	11-7/32"
Net Weight	Lbs.		41.3	75.0	41.3	90.4	41.3	90.4	41.3	75.0	41.3	97.0

Ceiling - Recessed			Air Conditioners						Heat Pumps					
Model No.	26PSU1U6		36PSU1U6		42PSU1U6		26PEU1U6		36PEU1U6		42PEU1U6			
Unit Model No.	Indoor Unit	Outdoor Unit	Indoor Unit	Outdoor Unit	Indoor Unit	Outdoor Unit	Indoor Unit	Outdoor Unit	Indoor Unit	Outdoor Unit	Indoor Unit	Outdoor Unit		
	S-26PU1U6	U-26PS1U6	S-36PU1U6	U-36PS1U6	S-42PU1U6	U-42PS1U6	S-26PU1U6	U-26PE1U6	S-36PU1U6	U-36PE1U6	S-42PU1U6	U-42PE1U6		
Grille Assembly	CZ-24KPU1U		CZ-36KPU1U		CZ-36KPU1U		CZ-24KPU1U		CZ-36KPU1U		CZ-36KPU1U			
<b>Performance &amp; Electrical Ratings</b>														
Capacity	Cooling	Btu/h	24,800 (9,500 ~ 24,800)		32,600 (9,500 ~ 32,600)		39,500 (9,500 ~ 39,500)		24,800 (9,500 ~ 24,800)		32,600 (9,500 ~ 32,600)		39,500 (9,500 ~ 39,500)	
	Heating	Btu/h	---		---		---		29,800 (8,000 ~ 29,800)		37,600 (8,000 ~ 37,600)		48,000 (8,000 ~ 48,000)	
Moisture Removal	High	Pints/H	8.1		10.6		12.6		8.1		10.6		12.6	
Dry Air Flow	Hi / Med / Low	CFM	710 / 530 / 450		1,050 / 840 / 720		1,050 / 840 / 720		710 / 530 / 450		1,050 / 840 / 720		1,050 / 840 / 720	
SEER	Cooling		14.1		14.6		14.6		14.1		14.6		14.6	
EER	Cooling		8.5		8.1		8.7		8.5		8.1		8.7	
HSPF	Heating		---		---		---		9.6		8.4		9.7	
Power Supply	V, Phase, Hz		230 / 208 / 1 / 60		230 / 208 / 1 / 60		230 / 208 / 1 / 60		230 / 208 / 1 / 60		230 / 208 / 1 / 60		230 / 208 / 1 / 60	
Running Amps	Cooling	A	15.6 / 17.3		18.7 / 20.7		23.0 / 25.4		15.6 / 17.3		18.7 / 20.7		23.0 / 25.4	
	Heating	A	---		---		---		14.8 / 16.4		15.9 / 17.6		22.4 / 24.8	
Power Input	Cooling	W	2,920 / 2,920		3,950 / 3,950		4,520 / 4,520		2,920 / 2,920		3,950 / 3,950		4,520 / 4,520	
	Heating	W	---		---		---		2,790 / 2,790		3,350 / 3,350		4,360 / 4,360	
Fuse or Circuit Breaker Capacity	A		15	30	15	35	15	40	15	30	15	35	15	40
<b>Features</b>														
Controls	Microprocessor		Microprocessor		Microprocessor		Microprocessor		Microprocessor		Microprocessor			
Low Ambient Control (for Cooling)	Built-in 0°F		Built-in 0°F		Built-in 0°F		Built-in 0°F		Built-in 0°F		Built-in 0°F			
Wireless Remote Controller (optional)	CZ-RWSU2U, CZ-RWSC1U		CZ-RWSU2U, CZ-RWSC1U		CZ-RWSU2U, CZ-RWSC1U		CZ-RWSU2U, CZ-RWSC1U		CZ-RWSU2U, CZ-RWSC1U		CZ-RWSU2U, CZ-RWSC1U			
Wired Remote Controller(included)	CZ-RTC2		CZ-RTC2		CZ-RTC2		CZ-RTC2		CZ-RTC2		CZ-RTC2			
Fan Speeds	3 and Automatic Control / Variable		3 and Automatic Control / Variable		3 and Automatic Control / Variable		3 and Automatic Control / Variable		3 and Automatic Control / Variable		3 and Automatic Control / Variable			
Timer	7 Days/6 Events		7 Days/6 Events		7 Days/6 Events		7 Days/6 Events		7 Days/6 Events		7 Days/6 Events			
Air Deflection	Horizontal		---		---		---		---		---			
	Vertical		Automatic		Automatic		Automatic		Automatic		Automatic			
Air Filter	Washable		Washable		Washable		Washable		Washable		Washable			
Refrigerant	R-410A		R-410A		R-410A		R-410A		R-410A		R-410A			
Refrigerant Control	Electric Expansion Valve		Electric Expansion Valve		Electric Expansion Valve		Electric Expansion Valve		Electric Expansion Valve		Electric Expansion Valve			
Operation Sound	In(Hi / Me / Lo)	dB-A	38 / 35 / 31		44 / 37 / 33		45 / 38 / 34		38 / 35 / 31		44 / 37 / 33		45 / 38 / 34	
	Outdoor(Hi)	dB-A	49		52		53		49		52		53	
Refrigerant Piping	Type		Flare		Flare		Flare		Flare		Flare		Flare	
	Discharge	inches	3/8"		3/8"		3/8"		3/8"		3/8"		3/8"	
	Suction	inches	5/8"		5/8"		5/8"		5/8"		5/8"		5/8"	
Refrigerant Pipe Length		Ft.	Max. 165		Max. 165		Max. 165t		Max. 165		Max. 165		Max. 165	
Elevation Difference*	Outdoor Above	Ft.	Max. 100		Max. 100		Max. 100		Max. 100		Max. 100		Max. 100	
	Outdoor Below	Ft.	Max. 50		Max. 50		Max. 50		Max. 50		Max. 50		Max. 50	
<b>Dimensions &amp; Weight</b>														
Height	inches		13-5/16"	30-23/32"	14-31/64"	30-23/32"	14-31/64"	48-7/16"	13-5/16"	30-23/32"	14-31/64"	30-23/32"	14-31/64"	48-7/16"
Width	inches		33-55/64"	37"	45-9/32"	37"	45-9/32"	37"	33-55/64"	37"	45-9/32"	37"	45-9/32"	37"
Depth	inches		33-55/64"	13-3/8"	33-55/64"	13-3/8"	33-55/64"	13-3/8"	33-55/64"	13-3/8"	33-55/64"	13-3/8"	33-55/64"	13-3/8"
Net Weight	Lbs.		49.0	128.0	60.0	143.0	60.0	220.0	49.0	128.0	60.0	143.0	60.0	220.0

\* This is maximum elevation difference when the indoor unit is located above the outdoor unit. (Refer to the table on the back of the catalog for more detail.)

# Concealed Duct Air Conditioners & Heat Pumps

26PSF1U6

26PEF1U6

## Indoor Unit

S-26PF1U6

Supplies are 8" dia



Outdoor Unit  
U-26PS1U6  
U-26PE1U6

Wired Remote Controller (CZ-RTC2) (Included)



36PSF1U6

36PEF1U6

## Indoor Unit

S-36PF1U6

Supplies are 8" dia



Outdoor Unit  
U-36PS1U6  
U-36PE1U6

Wired Remote Controller (CZ-RTC2) (Included)



## Outline diagram with medium or high-performance filter field installed.

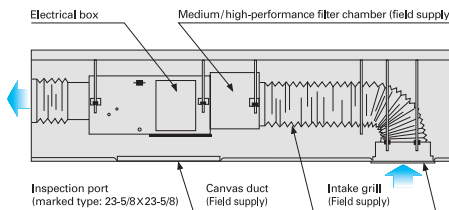

## Built-In Drain Pump

Drain pump is built into the unit to raise the condensate up 20 inches from the drain pump discharge.

## Installation Example

The picture shows the standard ducting system, where air is taken in from the back of the unit. This system is useful for places which need extensive air conditioning, including conference halls, showrooms, and restaurants.

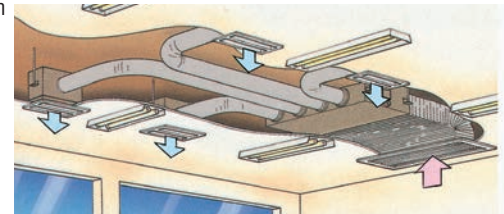

Ceiling Suspended Air Conditioners & Heat Pumps

Concealed Duct										
Air Conditioners										
Model No.	26PSF1U6		36PSF1U6		26PEF1U6		36PEF1U6		Unit Model No.	
	Indoor Unit	Outdoor Unit	Indoor Unit	Outdoor Unit	Indoor Unit	Outdoor Unit	Indoor Unit	Outdoor Unit		
Performance & Electrical Ratings										
Capacity	Cooling	Btu/h	24,000 (9,500 ~ 24,000)		31,200 (9,500 ~ 31,200)		24,000 (9,500 ~ 24,000)		31,200 (9,500 ~ 31,200)	
	Heating	Btu/h	---		---		28,600 (8,000 ~ 28,600)		36,200 (8,000 ~ 36,200)	
Moisture Removal	High	Pints/H	7.7		10.0		7.7		10.0	
Dry Air Flow	Hi / Med / Low	CFM	670 / 530 / 460		1,060 / 920 / 750		670 / 530 / 460		1,060 / 920 / 750	
SEER	Cooling		14.0		13.9		14.0		13.9	
EER	Cooling		9.1		7.8		9.1		7.8	
HSPF	Heating		---		---		9.0		8.5	
Power Supply	V, Phase, Hz		230 / 208, 1Ph, 60Hz		230 / 208, 1Ph, 60Hz		230 / 208, 1Ph, 60Hz		230 / 208, 1Ph, 60Hz	
Running Amps	Cooling	A	13.6 / 15.0		18.6 / 20.6		13.6 / 15.0		18.6 / 20.6	
	Heating	A	---		---		12.5 / 13.8		15.9 / 17.6	
Power Input	Cooling	W	2,600 / 2,600		3,920 / 3,920		2,600 / 2,600		3,920 / 3,920	
	Heating	W	---		---		2,400 / 2,400		3,340 / 3,340	
External Static Pressure		in. WC	0.20		0.24		0.20		0.24	
Fuse or Circuit Breaker Capacity		A	15	30	15	35	15	30	15	35
Features										
Controls	Microprocessor		Microprocessor		Microprocessor		Microprocessor		Microprocessor	
Low Ambient Control	Built-in 0°F		Built-in 0°F		Built-in 0°F		Built-in 0°F		Built-in 0°F	
Wireless Remote Controller (optional)	CZ-RWSU2U, CZ-RWSC1U		CZ-RWSU2U, CZ-RWSC1U		CZ-RWSU2U, CZ-RWSC1U		CZ-RWSU2U, CZ-RWSC1U		CZ-RWSU2U, CZ-RWSC1U	
Wired Remote Controller (included)	CZ-RTC2		CZ-RTC2		CZ-RTC2		CZ-RTC2		CZ-RTC2	
Fan Speeds	3 and Automatic Control / Variable		3 and Automatic Control / Variable		3 and Automatic Control / Variable		3 and Automatic Control / Variable		3 and Automatic Control / Variable	
Timer	7 Days/6 Events		7 Days/6 Events		7 Days/6 Events		7 Days/6 Events		7 Days/6 Events	
Air Deflection	Horizontal		---		---		---		---	
	Vertical		---		---		---		---	
Air Filter	---		---		---		---		---	
Refrigerant control	Electric Expansion Valve		Electric Expansion Valve		Electric Expansion Valve		Electric Expansion Valve		Electric Expansion Valve	
Operation Sound	In(Hi / Me / Lo)	dB-A	34 / 30 / 27		38 / 33 / 31		34 / 30 / 27		38 / 33 / 31	
	Outdoor(Hi)	dB-A	49		52		49		52	
Refrigerant Piping	Type		Flare		Flare		Flare		Flare	
	Discharge	inches	3/8"		3/8"		3/8"		3/8"	
	Suction	inches	5/8"		5/8"		5/8"		5/8"	
Refrigerant Pipe Length		Ft.	Max. 165		Max. 165		Max. 165		Max. 165	
Elevation Difference**	Outdoor Above	Ft.	Max. 100		Max. 100		Max. 100		Max. 100	
	Outdoor Below	Ft.	Max. 50		Max. 50		Max. 50		Max. 50	
Dimensions & Weight										
Height		inches	Indoor Unit	Outdoor Unit	Indoor Unit	Outdoor Unit	Indoor Unit	Outdoor Unit	Indoor Unit	Outdoor Unit
Width		inches	12-7/32"	30-23/32"	12-7/32"	30-23/32"	12-7/32"	30-23/32"	12-7/32"	30-23/32"
Depth		inches	39-3/8"	37"	58-9/32"	37"	39-3/8"	37"	58-9/32"	37"
Net Weight		Lbs.	24-13/16"	13-3/8"	24-13/16"	13-3/8"	24-13/16"	13-3/8"	24-13/16"	13-3/8"
			71.0	128.0	104.0	143.0	71.0	128.0	104.0	143.0

\*\* This is maximum elevation difference when the indoor unit is located above the outdoor unit. (Refer to the table on the back of the catalog for more detail.)



# Optional Accessories

**Condensate Pump**  
SI3100-1  
SI3100-2  
SI1730-2



**Tube size Reducer**  
CZ-MA1P



**Locking Bracket for Remote Control**  
RCS5PSB  
RCS4MHUB



**Wired Remote Controller**  
CZ-RD516C



**Timer Remote Controller**  
CZ-RTC2

**Replacement Anti-microbial Filter**  
CZ-SA20P



**Fresh Air Intake Plenum**  
CZ-26BCU1U  
CZ-42BCU1U



**Wired Remote Controller**  
CZ-RD515U



**System Controller**  
CZ-64ESMC1U

H.V.A.C. Accessories		
Model No.	Description	Use With
DL04060815	Insulated Tubing Kit 1/4" x 3/8" x 1/2" x 15'	S9NKU-1, S12NKU-1, S9NKUA, S12NKUA, KS12NB41A, E9NKUA, E12NKUA, KE12NB41, CU-2S18NBU-1, CU-2E18NBKU, CU-3KS19NBU, CU-4KS24NBU, CU-4KS31NBU, CU-3KE19NBU, CU-4KE24NBU, CU-4KE31NBU, CS-MKS7NKU, CS-MKS9NKU, CS-MKS12NKU, CS-MKE7NKU, CS-MKE9NKU, CS-MKE12NKU
DL04060820	Insulated Tubing Kit 1/4" x 3/8" x 1/2" x 20'	
DL04060835	Insulated Tubing Kit 1/4" x 3/8" x 1/2" x 35'	
DL04080815	Insulated Tubing Kit 1/4" x 1/2" x 1/2" x 15'	S18NKU-1, KS18NB4U, S18NKUA, KS18NKUA, KS18NB4UA, E18NKUA, KE18NKU, KE18NB4U, CU-3KS19NBU, CU-4KS24NBU, CU-4KS31NBU, CU-3KE19NBU, CU-4KE24NBU, CU-4KE31NBU, CS-MKS18NKU, CS-MKE18NKU
DL04080820	Insulated Tubing Kit 1/4" x 1/2" x 1/2" x 20'	
DL04080835	Insulated Tubing Kit 1/4" x 1/2" x 1/2" x 35'	
DL04100820	Insulated Tubing Kit 1/4" x 5/8" x 1/2" x 20'	KS24NKUA, KE24NKU, CU-4KS24NBU, CU-4KS31NBU, CU-4KE24NBU, CU-4KE31NBU, CS-MKS24NKU, CS-MKE24NKU
DL04100830	Insulated Tubing Kit 1/4" x 5/8" x 1/2" x 30'	
DL04100850	Insulated Tubing Kit 1/4" x 5/8" x 1/2" x 50'	
DL06100830	Insulated Tubing Kit 3/8" x 5/8" x 1/2" x 30'	All 26,000 Through 42,000 BTU/h Models
DL06100850	Insulated Tubing Kit 3/8" x 5/8" x 1/2" x 50'	All 26,000 Through 42,000 BTU/h Models
CZ-26BCU1U	Fresh Air Intake Plenum	S-26PU1U6
CZ-42BCU1U	Fresh Air Intake Plenum	S-36PU1U6, S-42PU1U6
RCS5PS4B	Locking Bracket for Remote Controller	CZ-RWSK1U, CZ-RWSU2U, CZ-RWSC1U
RCS4MHVB	Locking Bracket for Remote Controller	All models
BS600	Mounting Bracket for Outdoor Unit	CU-S9NKUA, CU-S9NKU-1, CU-E9NKUA, CU-S12NKUA, CU-S12NKU-1, CU-E12NKUA, CU-KS12NK1A, CU-KE12NK1, CU-S18NKUA, CU-S18NKU-1, CU-E18NKUA, CU-KS18NKU, CU-KS18NKUA, CU-KE18NKU, CU-S24NKUA, CU-S24NKU-1, CU-E24NKUA, CU-KS24NKUA, CU-KE24NKU, CU-KS30NKUA, CU-KE30NKU, CU-KS36NKUA, CU-KE36NKU, CU-2S18NBU, CU-2E18NBU-1, CU-3KS19NBU, CU-3KE19NBU, CU-4KS24NBU, CU-4KE24NBU, CU-4KS31NBU, CU-4KE31NBU
SI3100-1	Condensate Pump	All 115volt Models
SI3100-2	Condensate Pump	All 230 volt Models (up to 2ton)
SI1730-2	Condensate Pump	All 230 volt Models (High Vol. Condensate Removal) (2ton and higher)
CZ-RE2C2	Simple Wired Remote	All 26,000 Through 42,000 BTU/h Models
CZ-REL2C2	Simple Wired Remote with Backlight	
CZ-RD515U	Wired Remote Controller	ALL KE,KE,MKS & MKE Models
CZ-RD516C	Wired Remote Controller	S9NKUA, S12NKUA, S18NKUA, S24NKUA, E9NKUA, E12NKUA, E18NKUA, E24NKUA S9NKU-1, S12NKU-1, S18NKU-1, SEENKU-1
CZ-RC515U	Wire Kit	PCB Wire Kit for CZ-RD515U - Required For Use With All KS&KE Models except 30/36
CZ-RC515UA	Wire Kit	PCB Wire Kit for CZ-RD515U, CS-KS30NKU, CS-KS36NKU, CS-KE30NKU, CS-KE36NKU
CZ-RTC2	Wired Timer Remote Controller	All 26,000 Through 42,000 BTU/h Models
CZ-RWSK1U	Wireless Remote Controller	S-26PK1U6 / S-26PK1U6
CZ-RWSU2U	Wireless Remote Controller	S-26/36/42PT1U6, S-26/36/42PU1U6
CZ-RWSC1U	Wireless Remote Controller	S-26/36PF1U6
CZ-64ESMC1U	System Controller	All 26,000 Through 42,000 BTU/h Models
CZ-MA1P	Tube size Reducer	CS-S12NKUW-1,CS-E12NKUAW (for connection with CU-2S18NBU-1 / CU-2E18NBU)
CZ-SA20P	Replacement Anti-microbial Filter	CS-S9NKUA, S12NKUA, S9NKUW-1, S12NKUW-1, CS-S18NKU, CS-S22NKU, CS-S18NKU-1, CS-S22NKU-1, CS-E9NKUAW, CS-E12NKUAW, CS-E18NKUA, CS-E24NKUA
WINDB-1	Wind Baffle	All models

Optional Accessories

# Operation Range

## Cooling Models (S9/12/18/22NKU-1)

	Temperature	Indoor Air Intake Temp.	Outdoor Air Intake Temp.
Cooling	Maximum	90°F DB / 74°F WB	115°F DB
	Minimum	60°F DB / 52°F WB	60°F DB / 52°F WB

## Cooling Models 24,000 Btu and Less

	Temperature	Indoor Air Intake Temp.	Outdoor Air Intake Temp.
Cooling	Maximum	95°F DB / 71°F WB	115°F DB
	Minimum	67°F DB / 57°F WB	67°F DB

## Low Ambient Cooling Models (S9/12/18/24NKUA)

	Temperature	Indoor Air Intake Temp.	Outdoor Air Intake Temp.
Cooling	Maximum	90°F DB / 74°F WB	115°F DB
	Minimum	60°F DB / 52°F WB	0°F DB(S18/24) / 5°F DB (S9/12)

## Cooling Models above 26,000 Btu

	Temperature	Indoor Air Intake Temp.	Outdoor Air Intake Temp.
Cooling	Maximum	95°F DB / 71°F WB	115°F DB
	Minimum	67°F DB / 57°F WB	0°F DB

## Low Ambient Models 24,000 Btu and Less

	Temperature	Indoor Air Intake Temp.	Outdoor Air Intake Temp.
Cooling	Maximum	95°F DB / 71°F WB	115°F DB
	Minimum	67°F DB / 57°F WB	0°F DB

## Cooling Models KS30/36NKUA

	Temperature	Indoor Air Intake Temp.	Outdoor Air Intake Temp.
Cooling	Maximum	95°F DB / 71°F WB	115°F DB
	Minimum	67°F DB / 57°F WB	0°F DB

## RAC Multi KS Series Cooling Models

	Temperature	Indoor Air Intake Temp.	Outdoor Air Intake Temp.
Cooling	Maximum	95°F DB / 71°F WB	115°F DB
	Minimum	67°F DB / 57°F WB	14°F DB

## RAC Multi KE Series Heating Models

	Temperature	Indoor Air Take	Outdoor Air Take
Cooling	Maximum	95°F DB / 71°F WB	115°F DB
	Minimum	67°F DB / 57°F WB	14°F WB
Heating	Maximum	80°F DB / 67°F WB	75°F DB / 65°F WB
	Minimum	-°F WB / -°F WB	0°F WB

## Heat Pump Models (E9/12/18/24NKUA)

	Temperature	Indoor Air Intake Temp.	Outdoor Air Intake Temp.
Cooling	Maximum	90°F DB / 74°F WB	115°F DB
	Minimum	60°F DB / 52°F WB	0°F DB(E18/24) / 5°F DB (E9/12)
Heating	Maximum	86°F DB / -°F WB	75°F DB / 64°F WB
	Minimum	60°F DB / -°F WB	5°F DB / -°F WB

## Heat Pump Models 24,000 Btu and Less

	Temperature	Indoor Air Intake Temp.	Outdoor Air Intake Temp.
Cooling	Maximum	95°F DB / 71°F WB	115°F DB
	Minimum	67°F DB / 57°F WB	0°F DB
Heating	Maximum	80°F DB / 67°F WB	75°F DB / 65°F WB
	Minimum	-°F DB / -°F WB	0°F DB

## Heat Pump Models above 26,000 Btu

	Temperature	Indoor Air Intake Temp.	Outdoor Air Intake Temp.
Cooling	Maximum	95°F DB / 71°F WB	115°F DB
	Minimum	67°F DB / 57°F WB	0°F DB
Heating	Maximum	80°F DB / 67°F WB	75°F DB / 65°F WB
	Minimum	-°F DB / -°F WB	5°F DB

## Heat Pump Models above KE30/36NKU

	Temperature	Indoor Air Intake Temp.	Outdoor Air Intake Temp.
Cooling	Maximum	95°F DB / 71°F WB	115°F DB
	Minimum	67°F DB / 57°F WB	14°F DB
Heating	Maximum	80°F DB / 67°F WB	75°F DB / 65°F WB
	Minimum	-°F DB / -°F WB	0°F DB

## Sanyo to Panasonic Cross Reference

\* H/P: Heat Pump, C/O: Cooling Only

### PAC Outdoor 2types / 10models

Category	Capacity Kbtu/h	Model No.	Model No.	
PAC-i (Split)	H/P	26	CH2672R	U-26PE1U6
		36	CH3672R	U-36PE1U6
		42	CH4272R	U-42PE1U6
	C/O	30	CH3082	CU-KE30NKU
		36	CH3682	CU-KE36NKU
		26	C2672R	U-26PS1U6
36		C3672R	U-36PS1U6	
C/O	42	C4272R	U-42PS1U6	
	30	C3082	CU-KS30NKUA	
	36	C3682	CU-KS36NKUA	

### PAC Indoor 5types / 15models (13models, Panel : 2models)

Category	Capacity Kbtu/h	Model No.	Model No.	
4-Way Cassette	H/P	26	XHW2672R	S-26PU1U6
		36	XHW3672R	S-36PU1U6
		42	XHW4272R	S-42PU1U6
	Panel	PNR-XH2442	CZ-24KPU1U	
		PNR-XH3642	CZ-36KPU1U	
		PNR-XH3642	CZ-36KPU1U	
Wall Mount	H/P	26	KHS2672R	S-26PK1U6
Wall Mount	C/O	36	KS3082	CS-KS30NKU
		42	KS3682	CS-KS36NKU
	H/P	30	KHS3082	CS-KE30NKU
		36	KHS3682	CS-KE36NKU
Ceiling Suspended	H/P	26	THW2672R	S-26PT1U6
		36	THW3672R	S-36PT1U6
		42	THW4272R	S-42PT1U6
Duct	H/P	26	UHW2672R	S-26PF1U6
		36	UHW3672R	S-36PF1U6

## RAC (37models)

Category	Capacity Kbtu/h	Model No.	Model No.	
Wall Mount	Inv C/O	18	KS1872	CS-KS18NKU
		24	KS2472	CS-KS24NKU
		12	XS1271	CS-KS12NB41
		18	XS1872	CS-KS18NB4UW
Mini Cassette	Inv C/O	Panel	PNR-XS1872	CZ-18BT1U
		12	CL1271	CU-KS12NK1A
		18	C1872	CU-KS18NKU
		18	CL1872	CU-KS18NKUA
		24	C2472	CU-KS24NKU
		24	CL2472	CU-KS24NKUA
Wall Mount	Inv H/P	18	KHS1872	CS-KE18NKU
		24	KHS2472	CS-KE24NKU
		12	XHS1271	CS-KE12NB41
		18	XHS1872	CS-KE18NB4UW
		Panel	PNR-XS1872	CZ-18BT1U
		12	CH1271	CU-KE12NK1
Mini Cassette	Flexi Multi C/O	18	CH1872	CU-KE18NKU
		24	CH2472	CU-KE24NKU
		7	KMS0772	CS-MKS7NKU
		9	KMS0972	CS-MKS9NKU
Wall Mount	Flexi Multi C/O	12	KMS1272	CS-MKS12NKU
		18	KMS1872	CS-MKS18NKU
		24	KMS2472	CS-MKS24NKU
		9	XMS0972	CS-MKS9NB4U
		12	XMS1272	CS-MKS12NB4U
		Panel	PNR-XS1872	CZ-18BT1U
Mini Cassette	Flexi Multi H/P	19	CM1972A	CU-3KS19NBU
		24	CM2472A	CU-4KS24NBU
		31	CM3172A	CU-4KS31NBU
		7	KMHS0772	CS-MKE7NKU
Wall Mount	Flexi Multi H/P	9	KMHS0972	CS-MKE9NKU
		12	KMHS1272	CS-MKE12NKU
		18	KMHS1872	CS-MKE18NKU
		24	KMHS2472	CS-MKE24NKU
		9	XMHS0972	CS-MKE9NB4U
		12	XMHS1272	CS-MKE12NB4U
Mini Cassette	Flexi Multi H/P	Panel	PNR-XS1872	CZ-18BT1U
		19	CMH1972A	CU-3KE19NBU
		24	CMH2472A	CU-4KE24NBU
		31	CMH3172A	CU-4KE31NBU

## Controllers

Category	Model No.	Model No.	
Wireless RC	Common	RCS-BH80AAB.WL	CZ-RWSC1U
	4-Way Wall Mount	RCS-SH80AAB.WL	CZ-RWSU1U
		RCS-SH1AAB	CZ-RWSK1U
System Controller	SHA-KC64UG	CZ-64ESMC1U	
Simple Remote	RCS-KR1EG	CZ-RE2C2	
Simple Wired RC	NEW	CZ-RELC2	
Wireless RC	U1/T1 Series	RCS-SH80UA.WL	CZ-RWSU2U
Wired Kit		STK-KCW1	CZ-RC515U
		STK-KCW2	CZ-RC515UA
Wired RC		STK-RCS-7TWSUA	CZ-RD515U

## Accessories

Category	Model No.	Model No.	
Fresh Air intake	4-Way	CMB-GSJ80U	CZ-26BCU1U
	4-Way	CMB-GSJ140U	CZ-42BCU1U
Outdoor Bracket		STK-KSB2050	CZ-12UD1U
		STK-KSB5050	CZ-30UD1U

## Rating Conditions

	Cooling	Heating
Inside air temperature	80°F DB / 67°F WB	70°F DB / 60°F WB
Outside air temperature	95°F DB (75°F WB)	47°F DB / 43°F WB

# Tubing Sizes, Lengths & Elevation Differences, Refrigerant Charge Adjustment & Insulation Chart

SYSTEM MODEL	OD Tube Size (Inches)		Maximum length (ft) of tubing between In/Outdoor	Maximum Elevation difference (ft) between In/Outdoor		Maximum Length(ft) of Tubing at shipment	Required Additional Refrigerant Oz/ft	Insulation					
	Narrow	Wide		Outdoor Above	Outdoor Below								
S9NKU-1	1/4"	3/8"	49'	16'	16'	25'	R-410A 0.2	Both Tubes					
S9NKUA			66'	49'	49'								
E9NKUA				23'	23'				16'	R-410A 0.16			
KS12NB41A					49'						16'	R-410A 0.2	
KE12NB41				1/2"					66'	49'	49'		
S12NKU-1		100'	50'		50'	25'	R-410A 0.27						
S12NKUA									49'	49'	16'	R-410A 0.2	
E12NKUA													100'
S18NKU-1									66'	49'	49'	16'	
S18NKUA													100'
E18NKUA			66'		49'	49'	16'		R-410A 0.2				
KS18NKU										100'	49'	49'	33'
KS18NKUA			66'		49'	49'	16'		R-410A 0.2				
KE18NKU										100'	49'	49'	33'
KS18NB4U			66'	49'	49'	16'	R-410A 0.2						
KS18NB4UA		100'							49'	49'	33'	R-410A 0.2	
KE18NB4U			66'	49'	49'	16'	R-410A 0.2						
S22NKU-1		5/8"							131'	50'	50'	25'	R-410A 0.27
S24NKUA			100'	49'	49'	33'	R-410A 0.2						
KS24NKU		98'							49'	49'	33'	R-410A 0.2	
KS24NKUA	98'		49'	49'	33'	R-410A 0.2							
E24NKUA		98'					49'	49'	33'	R-410A 0.2			
KE24NKU	98'		49'	49'	33'	R-410A 0.2							
26PSK1U6		3/8"					5/8"	165'	100'	50'	100'	R-410A 0.43	Both Tubes
26PST1U6													
26PSU1U6													
26PSF1U6													
26PEK1U6													
26PET1U6													
26PEU1U6													
26PEF1U6													
KS30NKUA													
KE30NKU													
KS36NKUA													
KE36NKU													
36PST1U6													
36PSU1U6													
36PSF1U6													
36PET1U6													
36PEU1U6													
36PEF1U6													
42PST1U6													
42PSU1U6													
42PET1U6													
42PEU1U6													
CU-2S18NBU-1	1/4"	3/8"	82'	49'	49'	25'	R-410A 0.2						
CU-2E18NBU				3/8"x3, 1/2"x1	50'	50'		150'	R-410A 0.22				
CU-3KS19NBU													
CU-3KE19NBU													
CU-4KS24NBU													
CU-4KE24NBU													
CU-4KS31NBU													
CU-4KE31NBU													

Tubing Length

# Model code

## RAC

### Indoor Unit

C S - S 18 N K U -1  
1 2 3 4 5 6 7 8 9

### Outdoor Unit

C U - S 18 N K U -1  
1 2 3 4 5 6 7 8 9

### Set

S 18 N K U -1  
3 4 5 6 7 8 9

1 Series	2 ModelType	3 Connection configuration	4 Function	5 Capacity	6 Development	7 Category (Type)	8 Voltage	9 Others
C: Residential	S:Indoor unit U:Outdoor unit	K/None : Internal purpose MK : Indoor unit for Multi zone  Connected Type(Multi-zone) Numeral : Numeral+K	S : Cooling only E : Heat pump	Cooling Capacity in BTU/h	Development Series No.	K : Wall Mount B4 : Mini Ceiling Recessed  K : Internal	U : 208/230V, 60Hz 1 : 115V, 60Hz	-1 : Non-Low Ambient W : Multi/Single Zone common use  -1 : Non-Low Ambient

## PAC

### Indoor Unit

S - 26 P U 1 U6  
1 2 3 4 5 6

### Outdoor Unit

U - 36 P S 1 U6  
1 2 3 4 5 6

### Set

26 P S 1 U6  
2 3 4 5 6

1 ModelType	2 Capacity	3 Series	4 Category(Function)	5 Development	6 Voltage
S : Indoor unit	Cooling Capacity in BTU/h	P : Large Capacity series	K : Wall Mount U : Ceiling Recessed T : Ceiling suspended F : Concealed Duct	Development Series	U6 : 208/230V 60Hz
U : Outdoor Unit			S : Cooling Only H : Heat Pump		



Quality Management System Certificate



Certified to ISO 9001: 2008  
 Panasonic HA Air-Conditioning (M)  
 San.Bhd.  
 Cert. No.: MY-AR 1010

Environmental Management System Certificate



Certified to ISO 14001: 2004  
 Panasonic HA Air-Conditioning (M)  
 San.Bhd.  
 Cert. No.: MY-ER 0112

# Panasonic®



Panasonic Corporation of North America  
 Air Conditioning Group  
 1690 Roberts Blvd., NW, Suite 110, Kennesaw, GA 30144  
 WWW.PANASONIC.COM/AIRCON

**eco ideas** Panasonic leads the way... with "eco ideas"

**'eco ideas' for Lifestyles**

We will promote lifestyles with virtually zero CO<sub>2</sub> emissions all throughout the world

**'eco ideas' for Business-styles**

We will create and pursue a business-style which makes the best use of resources and energy

Because its products are subject to continuous improvements, Panasonic reserves the right to modify product design and specifications without notice and without incurring any obligations.  
 ©Copyright 2012, Panasonic Air Conditioning Products.

**Caution Related to Safety** Do not add or replace refrigerant other than the specified type. Manufacturer is not responsible for the damage and deterioration in safety due to usage of other refrigerant.